

USER MANUAL

DAP-1522

VERSION 1.3



Table of Contents

Product Overview	4	WLAN Partition	30
Package Contents.....	4	DHCP Server	31
System Requirements	4	DHCP Reservation	32
Introduction.....	5	QoS.....	33
Features.....	6	Traffic Manager	35
Hardware Overview	7	Add Traffic Manager Rule.....	36
Connections	7	Schedule.....	37
LEDs	8	Maintenance	38
Installation	9	Admin.....	38
Before you Begin	9	Time	39
Wireless Installation Considerations.....	10	System.....	40
AP/Bridge/Auto Mode	11	Language Pack	41
Configuration for AP Mode	13	Firmware.....	41
Web-based Configuration Utility	13	Status.....	43
Setup Wizard	14	Device Info	43
Wireless Setup Wizard.....	15	Wireless	44
Add Wireless Device With WPS.....	22	Logs	45
Manual Configuration.....	24	Statistics	46
Wireless Settings	24	Help	47
Network Settings.....	26	Configuration for Bridge Mode	48
DHCP	26	Web-based Configuration Utility	48
Static IP	27	Setup Wizard	49
Advanced.....	28	Wireless	57
MAC Address Filter	28	Wireless MAC Cloning.....	58
Advanced Wireless	29	Network Settings.....	59
		Static	59

DHCP	60	Connect to a Wireless Network	85
Advanced.....	61	Using Windows Vista®.....	85
Advanced Wireless	61	Configure WEP	87
QoS.....	62	Configure WPA-PSK	88
Schedule	64	Troubleshooting.....	89
Maintenance	65	Wireless Basics	93
Admin.....	65	What is Wireless?	94
Time.....	66	Tips.....	96
System.....	67	Wireless Modes	97
Language Pack.....	68	Networking Basics	98
Firmware.....	68	Check your IP address	98
Status.....	70	Statically Assign an IP address	99
Device Info	70	Technical Specifications.....	100
Logs.....	71		
Help	72		
Wireless Security.....	73		
What is WEP?.....	73		
What is WPA?	74		
Configure WEP in AP Mode	75		
Configure WPA-Personal (AP Mode)	76		
Configure WPA-Enterprise (AP Mode).....	77		
Configure WEP (Bridge Mode)	78		
Configure WPA-Personal (Bridge Mode)	79		
Connect to a Wireless Network	80		
Using Windows® XP	80		
Configure WEP	81		
Configure WPA-PSK	83		

Package Contents

- D-Link DAP-1522 Xtreme N Duo Wireless Bridge
- Power Adapter
- CAT5 Ethernet Cable
- Rubber Feet
- CD-ROM with User Manual



Note: Using a power supply with a different voltage than the one included with the DAP-1522 will cause damage and void the warranty for this product.

System Requirements

- Computers with Windows®, Macintosh®, or Linux-based operating systems with an installed Ethernet adapter
- Internet Explorer Version 6.0 or higher, Firefox 3.0 or higher, or Safari 3.0 or higher (for configuration)

Introduction

TOTAL PERFORMANCE

Combines award winning access point features and Draft 802.11n wireless technology to provide the best wireless performance.

TOTAL SECURITY

The most complete set of security features including WPA2 and MAC Address Control to protect your network against outside intruders.

TOTAL COVERAGE

Provides greater wireless signal rates even at farther distances for best-in-class Whole Home Coverage.

ULTIMATE PERFORMANCE

The D-Link Xtreme N™ Duo Wireless Bridge (DAP-1522) is a draft 802.11n compliant device that delivers real world performance of up to 650% faster than an 802.11g wireless connection (also faster than a 100Mbps wired Ethernet connection). Create a secure wireless network to share photos, files, music, video, printers, and network storage throughout your home. Connect the Xtreme N™ Duo Wireless Bridge to router and share your high-speed Internet access with everyone on the network. In addition, this Wireless Bridge includes a Quality of Service (QoS) engine that keeps digital phone calls (VoIP) and online gaming smooth and responsive, providing a better Internet experience.

EXTENDED WHOLE HOME COVERAGE

Powered by Xtreme N™ Duo technology, this high performance Wireless Bridge provides superior Whole Home Coverage while reducing dead spots. The Xtreme N™ Duo Wireless Bridge is designed for use in bigger homes and for users who demand higher performance networking. Add an Xtreme N™ Duo notebook or desktop adapter and stay connected to your network from virtually anywhere in your home.

TOTAL NETWORK SECURITY

The Xtreme N™ Duo Wireless Bridge supports all of the latest wireless security features to prevent unauthorized access, be it from over the wireless network or from the Internet. Support for WPA and WEP standards ensure that you'll be able to use the best possible encryption method, regardless of your client devices.

* Maximum wireless signal rate derived from IEEE Standard 802.11g, 802.11a and Draft 802.11n specifications. Actual data throughput will vary. Network conditions and environmental factors, including volume of network traffic, building materials and construction, and network overhead, lower actual data throughput rate. Environmental conditions will adversely affect wireless signal range.

Features

- **Faster Wireless Networking** - The DAP-1522 provides up to 300Mbps* wireless connection with other 802.11n wireless clients. This capability allows users to participate in real-time activities online, such as video streaming, online gaming, and real-time audio. The performance of this 802.11n wireless access point gives you the freedom of wireless networking at speeds 650% faster than 802.11g.
- **Compatible with 802.11a, 802.11b, and 802.11g Devices** - The DAP-1522 is still fully compatible with the IEEE 802.11a/b/g standard, so it can connect with existing 802.11a/b/g PCI, USB, and Cardbus adapters.
- **Advanced Firewall Features** - The Web-based user interface displays advanced network management features including Content Filtering, which allows easily applied content filtering based on MAC Address.
- **WPS PBC-** (Wi-Fi Protected Setup Push Button Configuration) Push Button Configuration is a button that can be pressed to add the device to an existing network or to create a new network. A virtual button can be used on the utility while a physical button is placed on the side of the device.
This easy setup method allows you to form a secured wireless link between the DAP-1522 and another WPS enabled device. A PC is no longer needed to log into the Web-based interface.
- **WPS PIN** - (Wi-Fi Protected Setup Personal Identification Number) A PIN is a unique number that can be used to add the access point to an existing network or to create a new network. The default PIN may be printed on the bottom of the access point. For extra security, a new PIN can be generated. You can restore the default PIN at any time. Only the Administrator (“admin” account) can change or reset the PIN.
- **User-friendly Setup Wizard** - Through its easy-to-use Web-based user interface, the DAP-1522 lets you control what information is accessible to those on the wireless network, whether from the Internet or from your company’s server. Configure your access point to your specific settings within minutes.

Hardware Overview

Connections

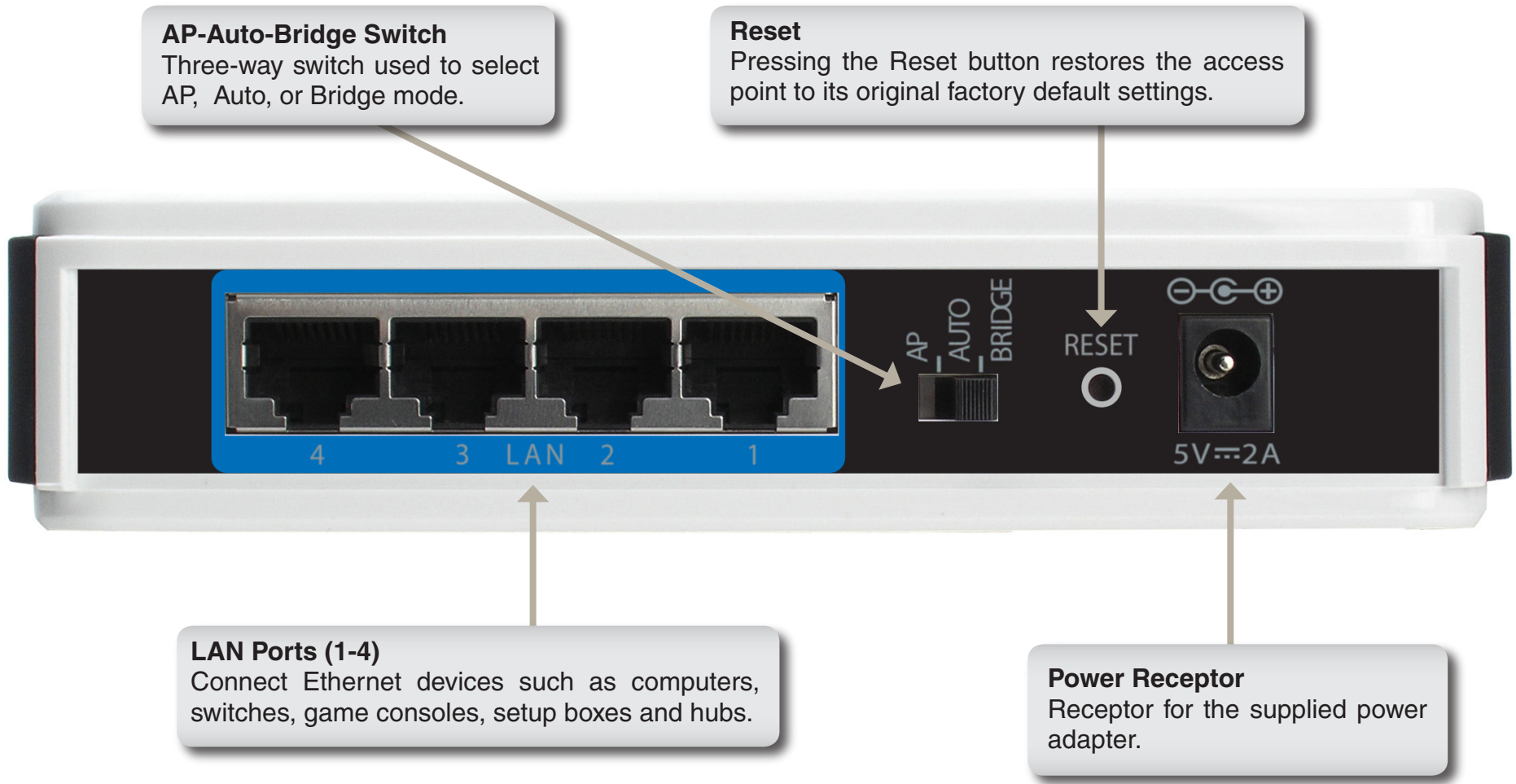

Hardware Overview

LEDs

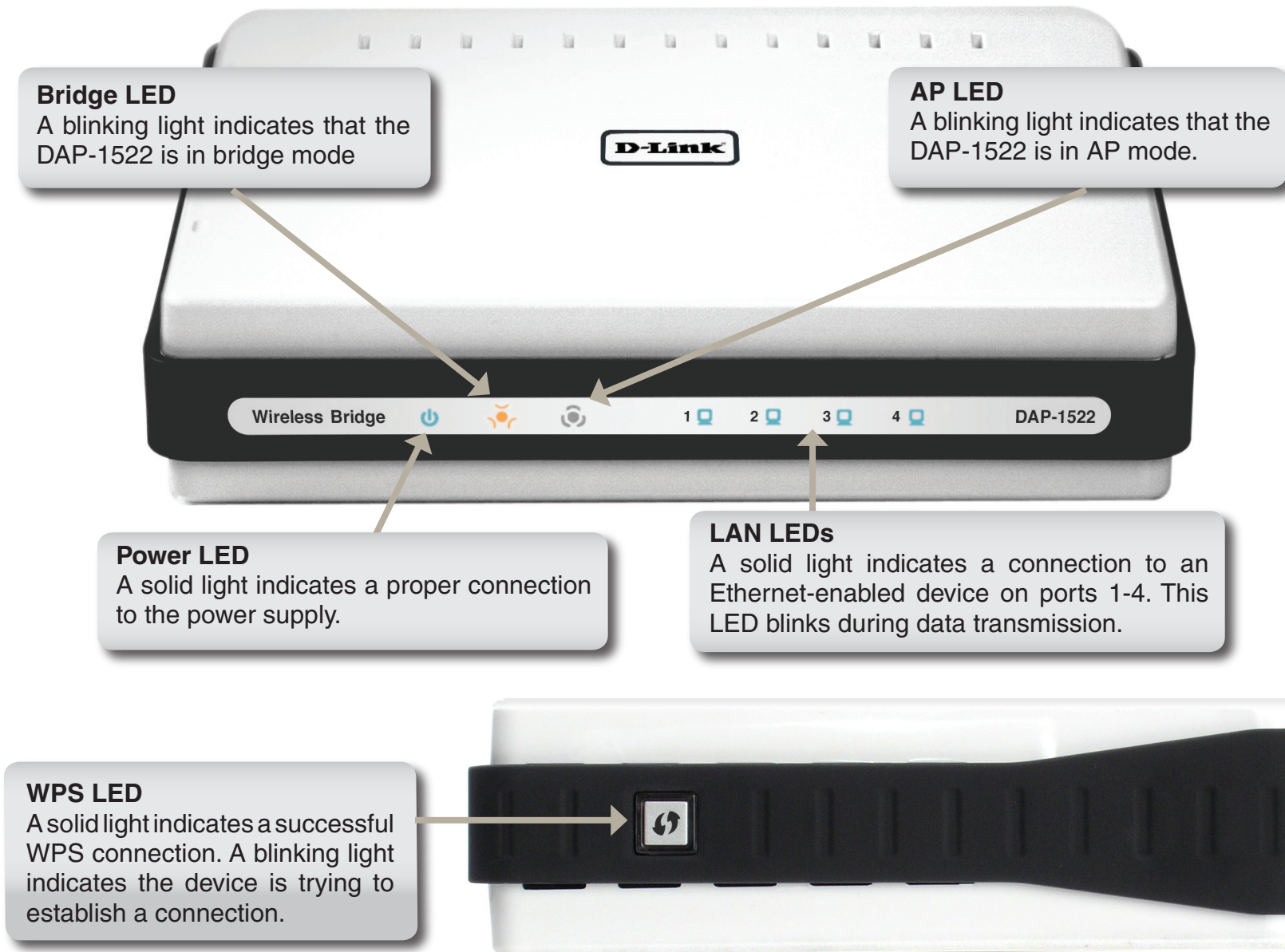

Installation

This section will walk you through the installation process. Placement of the DAP-1522 is very important. Do not place the DAP-1522 in an enclosed area such as a closet, cabinet, or in the attic or garage.

Before you Begin

Please configure the Wireless Bridge with the computer that was last connected directly to your modem. Also, you can only use the Ethernet port on your modem. If you were using the USB connection before using the Wireless Bridge, then you must turn off your modem, disconnect the USB cable and connect an Ethernet cable to the Internet port on the Wireless Bridge, and then turn the modem back on. In some cases, you may need to call your ISP to change connection types (USB to Ethernet).

If you have DSL and are connecting via PPPoE, make sure you disable or uninstall any PPPoE software such as WinPoet, Broadjump, or Enternet 300 from your computer or you will not be able to connect to the Internet.

Wireless Installation Considerations

The D-Link wireless access point lets you access your network using a wireless connection from virtually anywhere within the operating range of your wireless network. Keep in mind, however, that the number, thickness and location of walls, ceilings, or other objects that the wireless signals must pass through, may limit the range. Typical ranges vary depending on the types of materials and background RF (radio frequency) noise in your home or business. The key to maximizing wireless range is to follow these basic guidelines:

1. Keep the number of walls and ceilings between the D-Link access point and other network devices to a minimum. Each wall or ceiling can reduce your adapter's range from 3-90 feet (1-30 meters.) Position your devices so that the number of walls or ceilings is minimized.
2. Be aware of the direct line between network devices. A wall that is 1.5 feet thick (.5 meters), at a 45-degree angle appears to be almost 3 feet (1 meter) thick. At a 2-degree angle it looks over 42 feet (14 meters) thick! Position devices so that the signal will travel straight through a wall or ceiling (instead of at an angle) for better reception.
3. Building Materials make a difference. A solid metal door or aluminum studs may have a negative effect on range. Try to position access points, wireless access points, and computers so that the signal passes through drywall or open doorways. Materials and objects such as glass, steel, metal, walls with insulation, water (fish tanks), mirrors, file cabinets, brick, and concrete will degrade your wireless signal.
4. Keep your product away (at least 3-6 feet or 1-2 meters) from electrical devices or appliances that generate RF noise.
5. If you are using 2.4GHz cordless phones or X-10 (wireless products such as ceiling fans, lights, and home security systems), your wireless connection may degrade dramatically or drop completely. Make sure your 2.4GHz phone base is as far away from your wireless devices as possible. The base transmits a signal even if the phone is not in use.

AP/Bridge/Auto Mode

Depending on how you want to use your DAP-1522 will determine which mode you use. This section will help you figure out which setting works with your setup.

AP Mode

If you already have a wired or wireless router, and want to add a MediaBand (5GHz wireless), to your network, you will need to move the switch on the back panel of the DAP-1522 to “AP”.

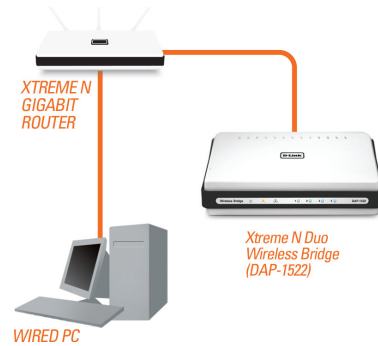

Bridge Mode

If you want to wirelessly connect multiple Ethernet enabled devices such as game consoles, media players, or network attached storage devices you will need to move the switch on the back panel of the DAP-1522 to “Bridge”.

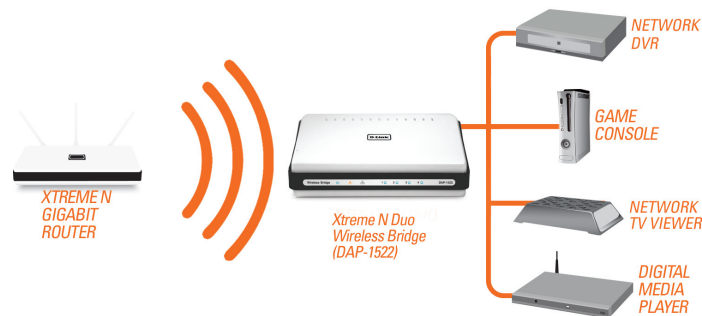

Auto Mode

If the switch on the back panel of the DAP-1522 is set to “Auto”, the device will wait for 30 seconds, looking for a DHCP server from the ethernet ports. If an IP address is assigned, it will automatically shift to AP mode. If an IP address is not assigned from a DHCP server, the DAP-1522 will automatically shift to Bridge mode.

Create a Full MediaBand (5GHz wireless) Network

If you have two DAP-1522 devices and want to create a wireless network with full MediaBand technology you will need to connect one Wireless Bridge to your router and move the switch on the back panel to “AP”. The second Wireless Bridge will need to be placed next to your Ethernet-enabled devices and you will need to move the switch on the back panel to “Bridge”.



Configuration for AP Mode

This section will show you how to configure your new D-Link wireless access point using the web-based configuration utility.

Web-based Configuration Utility

To access the configuration utility, open a web browser such as Internet Explorer and enter dlinkap or 192.168.0.50 in the address field.

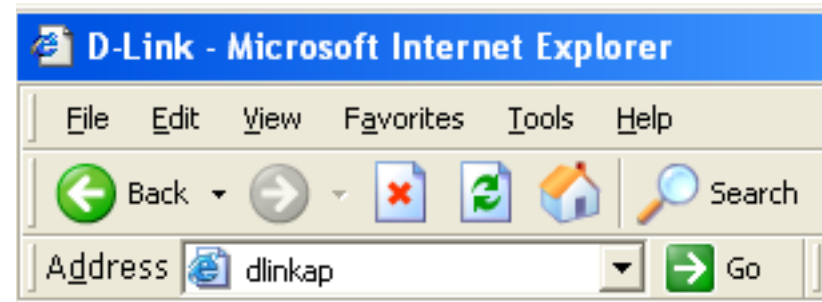

Select **Admin** from the drop-down menu and then enter your password. Leave the password blank by default.

If you get a Page Cannot be Displayed error, please refer to the Troubleshooting section for assistance.

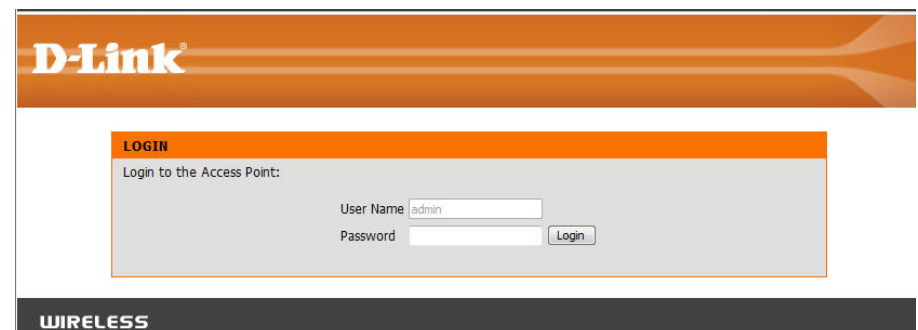

Setup Wizard

Click **Launch Wireless Setup Wizard** to quickly configure your access point.

To set up your wireless network, click **Add Wireless Device With WPS** and skip to page 22.

If you want to enter your settings without running the wizard, click **Manual Wireless Network Setup** and skip to page 24.

D-Link

DAP-1522 // SETUP ADVANCED MAINTENANCE STATUS HELP

WIRELESS SETTINGS

WIRELESS SETTINGS

The following Web-based wizards are designed to assist you in your wireless network setup and wireless device connection.

Before launching these wizards, please make sure you have followed all steps outlined in the Quick Installation Guide included in the package.

WIRELESS CONNECTION SETUP WIZARD

If you would like to utilize easy to use web-based wizard to assist you in connecting your DAP-1522 to the wireless network, click on the button below.

Launch Wireless Setup Wizard

Note: Some changes made using this Setup Wizard may require you to change some settings on your wireless client adapters so they can still connect to the D-Link Access Point.

MANUAL WIRELESS NETWORK SETUP

If your wireless network is already set up with Wi-Fi Protected Setup, manual configuration of the wireless network will destroy the existing wireless network. If you would like to configure the wireless settings of your new access point manually, then click on the Manual Wireless Network Setup button below.

Manual Wireless Network Setup

ADD A WIRELESS DEVICE WITH WPS (WIFI PROTECTED SETUP) WIZARD

This wizard is designed to assist you in connecting your DAP-1522 to wireless network using WPS. It will guide you through step-by-step instructions on how to get your wireless device connected. Click the button below to begin.

Add A Wireless Device With WPS

Helpful Hints...

If you already have a wireless network setup with Wi-Fi protection, click "Add A Wireless Device Wizard" to add a new device to your wireless network.

If you are new to wireless networking and have never configured a wireless access point before, click "Wireless Network Setup Wizard" and the access point will guide you through a few simple steps to get your wireless network up and running.

If you consider yourself an advanced user and have configured a wireless access point before, click "Manual Wireless Network Setup" to input all the settings manually.

More...

WIRELESS

Wireless Setup Wizard

This Wizard is designed to assist you in connecting your wireless device to your access point. It will guide you through step-by-step instructions on how to get your wireless device connected.

Enter the Device Name of the AP and click **Next** to continue. It is recommended to change the Device Name if there is more than one D-Link device within the subnet.

SET YOUR DEVICE NAME

Enter the Device Name of the AP. Recommend to change the Device Name if there're more than one D-Link devices within the subnet. Click **Next** to continue.

Device Name (NetBIOS Name)

If you want to change the admin account password, enter a new password and click **Next**.

SET YOUR NEW PASSWORD

You may change the **admin** account password by entering in a new password. Click **Next** to continue.

Password :

Verify Password :

Select Auto as the configuration method only if your wireless device supports Wi-Fi Protected Setup.

Skip to page 17 for Manual configuration.

Click **Next** to continue.

SELECT CONFIGURATION METHOD

Please select one of the following configuration methods and click next to continue.

Auto -- Select this option if your wireless device supports WPS (Wi-Fi Protected Setup)

Manual -- Select this option if you want to setup your network manually

Click **Save** to save your network settings.

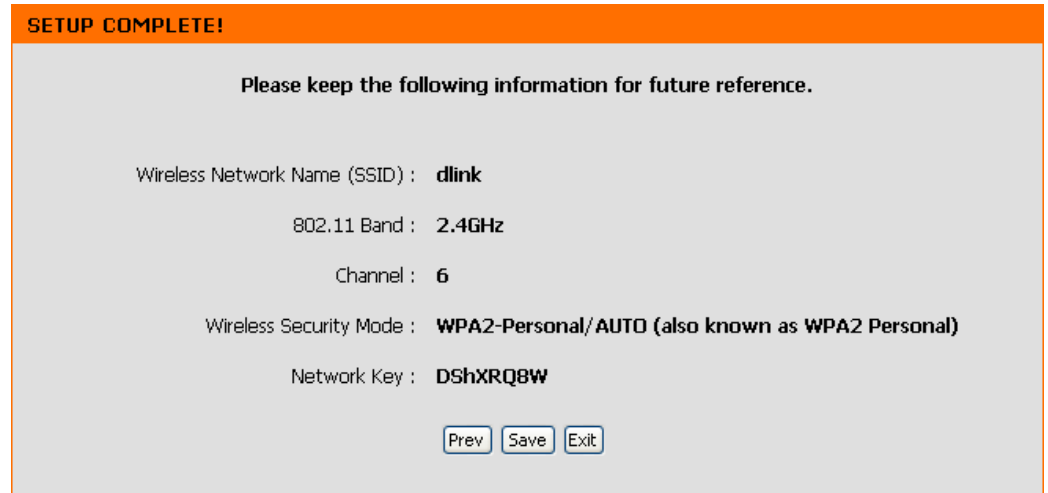

The following screen opens to indicate that you have successfully saved your new settings.

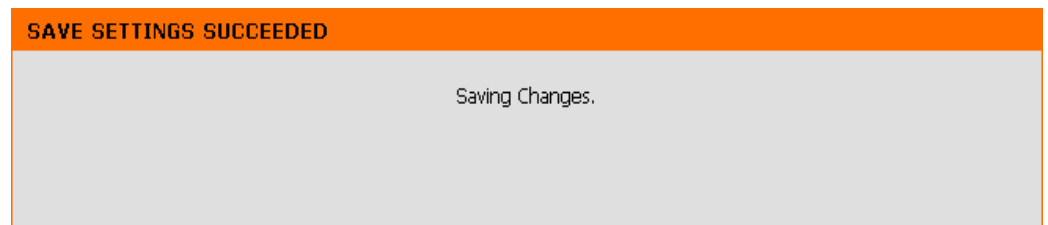

Select **Manual** as the configuration method to set up your network manually.

Click **Next** to continue.

SELECT CONFIGURATION METHOD

Please select one of the following configuration methods and click next to continue.

- Auto -- Select this option if your wireless device supports WPS (Wi-Fi Protected Setup)
- Manual -- Select this option if you want to setup your network manually

Prev Next Exit

Enter a network name and select Automatically assign a network key.

To Manually assign a network key, skip to page 19.

Click **Next** to continue.

WELCOME TO THE D-LINK WIRELESS SETUP WIZARD

Give your network a name, using up to 32 characters.

Network Name (SSID) : dlink

802.11 Band 2.4GHz 5GHz

Channel 1

Auto Channel Scan

- Automatically assign a network key (Recommended)
To prevent outsiders from accessing your network, the AP will automatically assign a security key (also called WEP or WPA key) to your network.
- Manually assign a network key
Use this option if your prefer to create your own key.

Use WPA encryption instead of WEP (WPA is stronger than WEP and all D-Link wireless client adapters support WPA).

Prev Next Exit

If you choose WPA-PSK encryption, the following screen will show you your Network Key to enter on your wireless clients.

Click **Save** to finish the Setup Wizard.

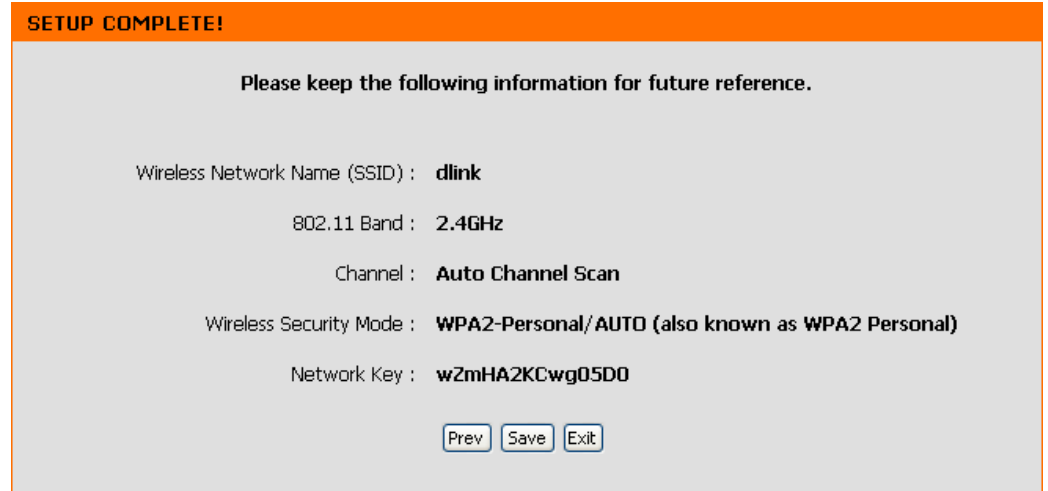

If you choose WEP encryption, the following screen will show you your Network Key to enter on your wireless clients.

Click **Save** to finish the Setup Wizard.



Choose **Manually** assign a network key to create your own key.

Click **Next** to continue.

WELCOME TO THE D-LINK WIRELESS SETUP WIZARD

Give your network a name, using up to 32 characters.

Network Name (SSID) :

802.11 Band 2.4GHz 5GHz

Channel

Auto Channel Scan

Automatically assign a network key (Recommended)
To prevent outsiders from accessing your network, the AP will automatically assign a security key (also called WEP or WPA key) to your network.

Manually assign a network key
Use this option if your prefer to create your own key.

Use WPA encryption instead of WEP (WPA is stronger than WEP and all D-Link wireless client adapters support WPA).

For WPA encryption, enter a Network Key between 8 and 63 characters long or enter exactly 64 characters using 0-9 and A-F.

Click **Next** to continue.

WELCOME TO THE D-LINK WIRELESS SETUP WIZARD

The WPA (Wi-Fi Protected Access) key must meet one of the following guidelines

- Between 8 and 63 ASCII characters or 64 hex characters(A longer WPA key is more secure than a short one)

Network Key :

If you select WPA encryption, the following screen will show you your network key to enter on your wireless clients.

Click **Save** to finish the Setup Wizard.



For **WEP** encryption, enter a Network Key exactly 5 or 13 characters long or exactly 10 or 26 characters using 0-9 and A-F.

Click **Next** to continue.

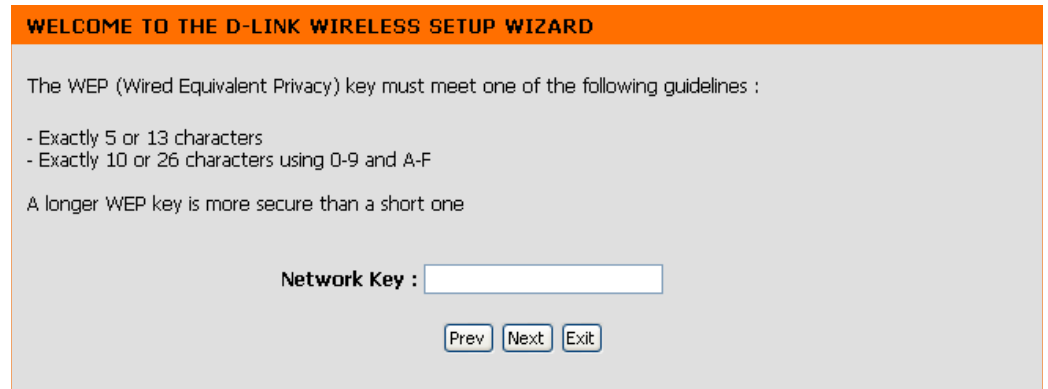

If you select **WEP** encryption, the following screen will show you your network key to enter on your wireless clients.

Click **Save** to finish the Setup Wizard.

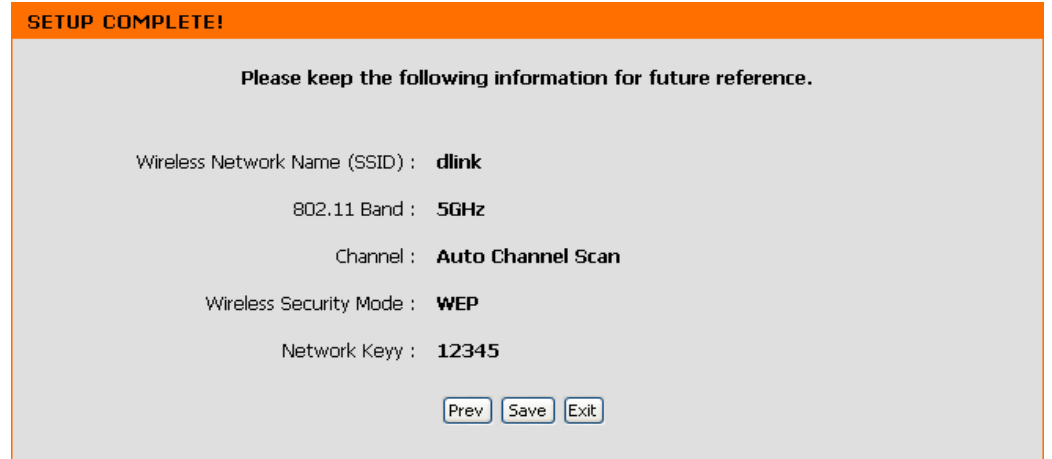

Add Wireless Device With WPS

This Wizard is designed to assist you in your wireless network setup. It will guide you through step-by-step instructions on how to set up your wireless network and how to make it secure.

Select **PIN** to use your **PIN** number from your wireless device to connect to your network.

For **PBC** configuration, skip to page 23.

Click **Connect** to continue.

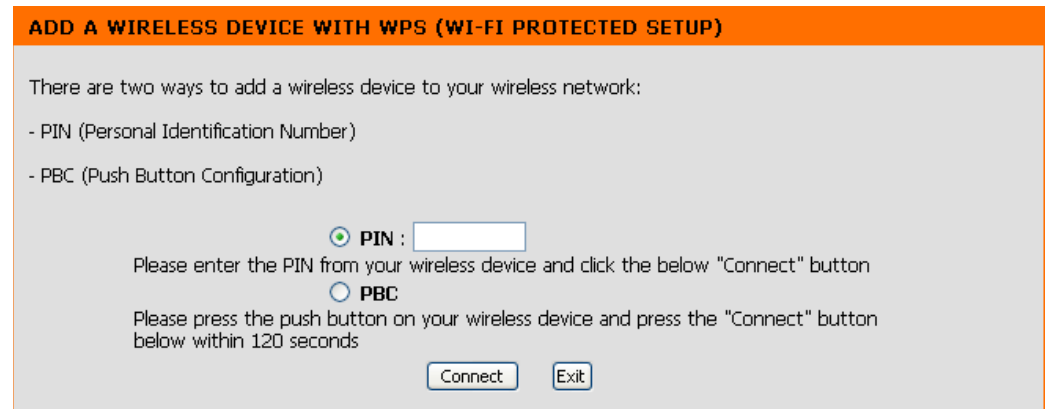

ADD A WIRELESS DEVICE WITH WPS (WI-FI PROTECTED SETUP)

There are two ways to add a wireless device to your wireless network:

- PIN (Personal Identification Number)
- PBC (Push Button Configuration)

PIN :

Please enter the PIN from your wireless device and click the below "Connect" button

PBC

Please press the push button on your wireless device and press the "Connect" button below within 120 seconds

Start **WPS** on the wireless device you are adding to your wireless network to complete the setup.

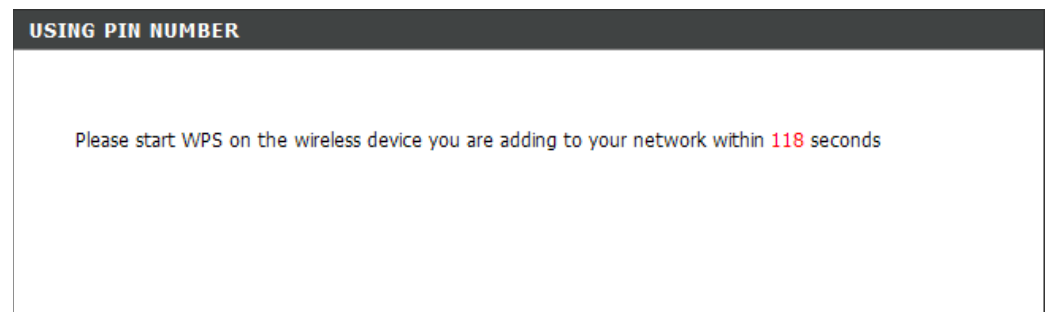

USING PIN NUMBER

Please start WPS on the wireless device you are adding to your network within **118** seconds

Select **PBC** to use the Push Button Configuration in order to connect to your network.

Click **Connect** to continue.

Press down the **Push Button** on the wireless device that you are adding to your network to complete the setup.

ADD A WIRELESS DEVICE WITH WPS (WI-FI PROTECTED SETUP)

There are two ways to add a wireless device to your wireless network:

- PIN (Personal Identification Number)
- PBC (Push Button Configuration)

PIN :

Please enter the PIN from your wireless device and click the below "Connect" button

PBC

Please press the push button on your wireless device and press the "Connect" button below within 120 seconds

Connect

Exit

VIRTUAL PUSH BUTTON

Please press down the Push Button (physical or virtual) on the wireless device you are adding to your wireless network within **116** seconds ...

Manual Configuration

Wireless Settings

Wireless Mode: The current wireless mode is set to Access Point, it will create a wireless infrastructure network.

Enable Wireless: Check the box to enable the wireless function. If you do not want to use wireless, uncheck the box to disable all the wireless functions.

Wireless Network Name: When you are browsing for available wireless networks, this is the name that will appear in the list (unless Visibility Status is set to Invisible, see below). This name is also referred to as the SSID. For security purposes, it is highly recommended to change from the pre-configured network name.

802.11 Band: Operating frequency band. Choose 2.4GHz for visibility to legacy devices and for longer range. Choose 5GHz for least interference.

802.11 Mode: If you choose 2.4GHz band, then select one of the following:

Mixed 802.11n, 802.11g and 802.11b - Select if you are using a mix of 802.11n, 11g, and 11b wireless clients.

802.11b Only - Select if you are only using 802.11b wireless clients.

802.11g Only - Select if you are only using 802.11g wireless clients.

802.11n Only - Select if you are only using 802.11n wireless clients.

Mixed 802.11g and 802.11b - Select if you are using a mix of 802.11g and 11b wireless clients.

Mixed 802.11n and 802.11g - Select if you are using a mix of 802.11n and 11g wireless clients.

If you choose 5GHz band, then select either **802.11a Only**, **802.11n Only**, or **Mixed 802.11n and 802.11a**.

D-Link

DAP-1522 // SETUP ADVANCED MAINTENANCE STATUS HELP

WIRELESS NETWORK

Use this section to configure the wireless settings for your access point. Please note that changes made on this section may also need to be duplicated on your Wireless Client.

Save Settings Don't Save Settings

WIRELESS NETWORK SETTINGS

Wireless Mode : Access Point

Enable Wireless :

Wireless Network Name : dlink (Also called the SSID)

802.11 Band : 2.4GHz 5GHz

802.11 Mode : Mixed 802.11n and 802.11a

Enable Auto Channel Scan :

Wireless Channel : 36

Transmission Rate : Best(automatic) (Mbit/s)

Channel Width : 20 MHz

Visibility Status : Visible Invisible

WIRELESS SECURITY MODE

Security Mode : Disable Wireless Security (not recommended)

WI-FI PROTECTED SETUP (ALSO CALLED WCN 2.0 IN WINDOWS VISTA)

Enable :

Lock Wireless Security Settings :

Current PIN : 12345678

Generate New PIN Reset PIN to Default

Wi-Fi Protected Status : Enabled / Configured

Reset to Unconfigured

Helpful Hints..

Changing your Wireless Network Name is the first step in securing your wireless network. Change to a familiar name that not contain any person information.

Auto Channel Scan is set default. It automatically finds the least loaded channel for interference free communication.

Enabling Hidden Mode is another way to secure network. With this option enabled, no wireless client will be able to see your wireless network when scan to see what's available. For your wireless device connect to your access point, you will need to manually enter the Wireless Network Name on each device.

If you have enabled Wireless Security, make you write down the WEP Key or Passphrase that have configured. You will need to enter this information on any wireless device that you connect your wireless network.

More...

Enable Auto Channel Scan: The Auto Channel Scan setting can be selected to allow the DAP-1522 to choose the channel with the least amount of interference.

Wireless Channel: Indicates the channel setting for the DAP-1522. The Channel can be changed to fit the channel setting for an existing wireless network or to customize the wireless network. If you enable Auto Channel Scan, this option will be grayed out.

Transmission Rate: Select the transmit rate. It is strongly suggested to select **Best (automatic)** for best performance.

Channel Width: Select the Channel Width:
Auto 20/40 - Select if you are using both 802.11n and non-802.11n wireless devices.
20MHz - Select if you are not using any 802.11n wireless clients.

Visibility Status: Select **Invisible** if you do not want the SSID of your wireless network to be broadcasted by the DAP-1522. If Invisible is selected, the SSID of the DAP-1522 will not be seen by Site Survey utilities so your wireless clients will have to know the SSID of your DAP-1522 in order to connect to it.

Security Mode: Refer to page 65 for more information regarding the wireless security.

Enable: Enable the Wi-Fi Protected Setup feature.

Lock Wireless Security Settings: Locking the wireless security settings prevents the settings from being changed by any new external user using its PIN. Devices can still be added to the wireless network using Wi-Fi Protected Setup. It is still possible to change wireless network settings with Manual Wireless Network Setup, Wireless Network Setup Wizard, or an existing external WLAN Manager user.

Current PIN: Shows the current value of the access point's PIN.

Generate New PIN: Create a random number that is a valid PIN. This becomes the access point's PIN. You can then copy this PIN to the user interface of the user.

Reset PIN to Default: Restore the default PIN of the access point.

Reset to Unconfigured: Resets Wi-Fi Protected Status to Not Configured. Vista WPS icon will only be displayed when the Wi-Fi Protected Status is Not Configured.

Network Settings

DHCP

This section will allow you to change the local network settings of the access point and to configure the DHCP settings.

LAN Connection Type: Use the drop-down menu to select Dynamic IP (DHCP) to automatically obtain an IP address on the LAN/private network.

Device Name: Enter the Device Name of the AP. It is recommended to change the Device Name if there is more than one D-Link device within the subnet.

The screenshot shows the D-Link DAP-1522 web interface. The top navigation bar includes tabs for SETUP, ADVANCED, MAINTENANCE, STATUS, and HELP. The main content area is divided into three sections:

- NETWORK SETTINGS:** This section is highlighted in orange. It contains instructions for configuring the internal network settings and a built-in DHCP server. Below the text are two buttons: "Save Settings" and "Don't Save Settings".
- ACCESS POINT SETTINGS:** This section contains instructions for configuring the access point's internal network settings. It features a dropdown menu for "LAN Connection Type" which is currently set to "Dynamic IP (DHCP)".
- DEVICE NAME (NETBIOS NAME):** This section contains a text input field for "Device Name" with the value "dlinkap" entered.

On the right side of the interface, there is a "Helpful Hints..." section with additional information about LAN settings and a "More..." link at the bottom.

Static IP

LAN Connection Type: Use the drop-down menu to select **Static IP**.

Access Point IP Address: Enter the IP address of the access point. The default IP address is 192.168.0.50. If you change the IP address, once you click **Apply**, you will need to enter the new IP address in your browser to get back into the configuration utility.

Subnet Mask: Enter the Subnet Mask assigned by your ISP.

Default Gateway: Enter the Gateway assigned by your ISP.

Device Name: Enter the Device Name of the AP. It is recommended to change the Device Name if there is more than one D-Link device within the subnet.

D-Link

DAP-1522

SETUP ADVANCED MAINTENANCE STATUS HELP

WIRELESS SETTINGS

NETWORK SETTINGS

NETWORK SETTINGS

Use this section to configure the internal network settings of your access point and also to configure the built-in DHCP Server to assign IP addresses to the computers on your network. The IP Address that is configured here is the IP Address that you use to access the Web-based management interface. If you change the IP Address here, you may need to adjust your PC's network settings to access the network again.

Save Settings Don't Save Settings

ACCESS POINT SETTINGS

Use this section to configure the internal network settings of your access point. The IP Address that is configured here is the IP Address that you use to access the Web-based management interface. If you change the IP Address here, you may need to adjust your PC's network settings to access the network again.

LAN Connection Type :

Access Point IP Address :

Subnet Mask :

Default Gateway :

DEVICE NAME (NETBIOS NAME)

Device Name :

Helpful Hints..

Also referred as private settings. LAN settings allow you to configure LAN interface of DAP-1522. LAN IP address is private to your internal network and is not visible to internet. The default IP address is 192.168.0.50 with subnet mask as 255.255.255.0.

LAN Connection-The factory default setting is "Dynamic IP (DHCP)" to allow the DHCP host to automatically assign the Access Point an IP address that conforms to the applied local area network. Enable "Static IP" to allow the IP Address of the DAP-1522 to be manually configured in accordance to the applied local area network.

3

[More...](#)

Advanced MAC Address Filter

The MAC address filter section can be used to filter network access by machines based on the unique MAC addresses of their network adapter(s). It is most useful to prevent unauthorized wireless devices from connecting to your network. A MAC address is a unique ID assigned by the manufacturer of the network adapter.

Configure MAC Filtering: When **Turn MAC Filtering OFF** is selected, MAC addresses are not used to control network access. When **Turn MAC Filtering ON and ALLOW computers listed to access the network** is selected, only computers with MAC addresses listed in the MAC Address List are granted network access. When **Turn MAC Filtering ON and DENY computers listed to access the network** is selected, any computer with a MAC address listed in the MAC Address List is refused access to the network.

Add MAC Filtering Rule: This parameter allows you to manually add a MAC filtering rule. Click the **Add** button to add the new MAC filtering rule to the MAC Filtering Rules list at the bottom of this screen.

D-Link

DAP-1522 // SETUP ADVANCED MAINTENANCE STATUS HELP

MAC ADDRESS FILTER

The MAC (Media Access Controller) Address filter option is used to control network access based on the MAC Address of the network adapter. A MAC address is a unique ID assigned by the manufacturer of the network adapter. This feature can be configured to ALLOW or DENY network access.

Save Settings Don't Save Settings

MAC FILTERING SETUP

Configure MAC Filtering below :
Turn MAC Filtering OFF

ADD MAC FILTERING RULE

MAC Address : : : : : :

MAC FILTERING RULES

MAC Address	Delete	MAC Address	Delete

Helpful Hints...

Create a list of MAC addresses that you would either like to allow or deny access to your network.

Select filter OFF, ALLOW or DENY, enter a MAC address, and then click the "Add" button to add a new MAC filtering rule.

Click the delete icon to remove the MAC address from the MAC filtering rules.

More...

Advanced Wireless

Transmit Power: Sets the transmit power of the antennas.

Beacon Period: Beacons are packets sent by an Access Point to synchronize a wireless network. Specify a value. 100 is the default setting and is recommended.

DTIM Interval: (Delivery Traffic Indication Message) 1 is the default setting. A DTIM is a countdown informing clients of the next window for listening to broadcast and multicast messages.

RTS Threshold: This value should remain at its default setting of 2346. If inconsistent data flow is a problem, only a minor modification should be made.

Fragmentation Threshold: The fragmentation threshold, which is specified in bytes, determines whether packets will be fragmented. Packets exceeding the 2346 byte setting will be fragmented before transmission. 2346 is the default setting.

WMM Enable: WMM is QoS for your wireless network. This will improve the quality of video and voice applications for your wireless clients.

Short GI: Check this box to reduce the guard interval time therefore increasing the data capacity. However, it is less reliable and may create higher data loss.

IGMP Snooping: This enables IGMP snooping for the wireless connection. We recommend enabling this if you often use multicast services such as video conferencing and streaming audio/video.

D-Link

DAP-1522 // SETUP ADVANCED MAINTENANCE STATUS HELP

ADVANCED WIRELESS

If you are not familiar with these Advanced Wireless settings, please read the help section before attempting to modify these settings.

Save Settings Don't Save Settings

ADVANCED WIRELESS SETTINGS

Transmit Power : 100% ▾

Beacon Period : 100 (msec, range:25~500, default:100)

DTIM Interval : 1 (range: 1~15, default:1)

RTS Threshold : 2346 (range: 256~2346, default:2346)

Fragmentation Threshold : 2346 (range: 1500~2346, default:2346, even number only)

WMM Enable :

Short GI :

IGMP Snooping :

Helpful Hints...

It is recommended that you leave these parameters at their default values. Adjusting them could limit the performance of your wireless network.

Enabling WMM can help control latency and jitter when transmitting multimedia content over a wireless connection.

More...

WLAN Partition

WLAN Partition allows you to segment your Wireless network by managing access to both the internal station and Ethernet access to your WLAN.

Internal Station Connection: Use the drop-down menu to either Allow or Deny internal station connection.

Ethernet to WLAN Access: Use the drop-down menu to either Allow or Deny Ethernet to Wireless LAN access.

The screenshot displays the D-Link DAP-1522 web interface. The main content area is titled "WLAN PARTITION SETTINGS" and contains the following configuration options:

- Internal Station Connection : (dropdown menu)
- Ethernet to WLAN Access : (dropdown menu)

At the top of the settings area, there are two buttons: "Save Settings" and "Don't Save Settings". The interface also includes a sidebar on the left with navigation tabs: "MAC ADDRESS FILTER", "ADVANCED WIRELESS", "WLAN PARTITION", "DHCP SERVER", "QOS", "TRAFFIC MANAGER", and "SCHEDULE". On the right side, there is a "HELP" tab and a "Helpful Hints..." section with explanatory text.

DHCP Server

DHCP stands for Dynamic Host Control Protocol. The DAP-1522 has a built-in DHCP server. The DHCP Server will automatically assign an IP address to the computers on the LAN/private network. Be sure to set your computers to be DHCP clients by setting their TCP/IP settings to “Obtain an IP Address Automatically.” When you turn your computers on, they will automatically load the proper TCP/IP settings provided by the DAP-1522. The DHCP Server will automatically allocate an unused IP address from the IP address pool to the requesting computer.

Enable DHCP Server: Check to enable the DHCP Server on the access point.

IP Address From/To: Enter the IP address range to assign to the clients on your network.

Note: If you statically (manually) assign IP addresses to your computers or devices, make sure the IP addresses are outside of this range or you may have an IP conflict.

Default Subnet Mask: Enter the subnet mask.

Default Gateway: Enter the default gateway IP address.

Default Wins: Enter the WINS server IP address.

Default DNS: Enter the DNS server IP address.

DHCP Lease Time: Enter the DHCP lease time (in minutes).

DHCP Client List: Clients on your network that are assigned IP addresses will be displayed here.

The screenshot shows the D-Link DAP-1522 web interface. The top navigation bar includes 'D-Link', 'DAP-1522', and tabs for 'SETUP', 'ADVANCED', 'MAINTENANCE', 'STATUS', and 'HELP'. The left sidebar lists various configuration sections: 'MAC ADDRESS FILTER', 'ADVANCED WIRELESS', 'WLAN PARTITION', 'DHCP SERVER', 'QOS', 'TRAFFIC MANAGER', and 'SCHEDULE'. The main content area is titled 'NETWORK SETTING' and contains the following information:

NETWORK SETTING
Use this section to configure the internal network settings of your Access Point and also to configure the built-in DHCP server to assign IP address to the computers on your network. The IP address that is configured here is the IP address that you use to access the Web-based management interface. If you change the IP address here, you may need to adjust your PC's network settings to access the network again.

Please note that this section is optional and you do not need to change any of the settings here to get your network up and running.

Buttons: Save Settings, Don't Save Settings

DHCP SERVER SETTINGS
Use this section to configure the built-in DHCP server to assign IP address to the computers on your network.

Enable DHCP Server :
 IP Assigned From : 192.168.0.20 to 254
 Default Subnet Mask : 255.255.255.0
 Default Gateway :
 Default Wins :
 Default DNS :
 DHCP Lease Time : 10080 (minutes)

DHCP CLIENT LIST

Host Name	IP Address	MAC Address	Expired Time
16 - DHCP RESERVATION			
Remaining number of clients that can be configured : 16			
<input type="checkbox"/>	<input type="text"/>	<input type="text"/>	<< Computer Name v
<input type="checkbox"/>	<input type="text"/>	<input type="text"/>	<< Computer Name v
<input type="checkbox"/>	<input type="text"/>	<input type="text"/>	<< Computer Name v

Helpful Hints...
If you already have a DHCP server on your network or are using static IP addresses on all the devices on your network, uncheck **Enable DHCP Server** to disable this feature.
More...

DHCP Reservation

If you want a computer or device to always have the same IP address assigned, you can create a DHCP reservation. The access point will assign the IP address only to that computer or device.

Note: This IP address must be within the DHCP IP Address Range.

Enable: Check this box to enable the reservation.

Computer Name: Enter the computer name or select from the drop-down menu.

IP Address: Enter the IP address you want to assign to the computer or device. This IP Address must be within the DHCP IP Address Range.

MAC Address: Enter the MAC address of the computer or device.

QoS

The Quality of Service (QoS) feature regulates the flow of data through the access point by assigning a priority to each packet. It enhances your experience of wireless network usage by prioritizing the traffic of different applications. Enabling this option allows the AP to prioritize traffic. There are two options available for the special application.

Enable QoS: Enable this option if you want QoS to prioritize your traffic.

QoS Type: There are two options available for your special application: (1) Priority by LAN Port, and (2) Priority by Protocol.

Priority by LAN Port: There are four priority levels for all LAN ports. The priority level values assigned are 1 for Background, 3 for Best Effort, 5 for Video, and 7 for Voice (Voice is the highest level and Background is the lowest level) at a normal priority.

D-Link

DAP-1522 // SETUP ADVANCED MAINTENANCE STATUS HELP

QoS

QoS prioritizes the traffic of various wireless applications.

Save Settings Don't Save Settings

QoS

Enable QoS :

QoS Type : Priority by LAN Port

PORT QoS

LAN Port 1 Priority : Background

LAN Port 2 Priority : Best Effort

LAN Port 3 Priority : Video

LAN Port 4 Priority : Voice

Helpful Hints...

Enable this option if you want to allow QoS to prioritize wireless traffic.

There are two options for QoS Type selected, such as priority by Lan port and by protocol, which ensure the right priorities available for your special applications.

More...

Priority by Protocol: Users can set the priority and percentage of total bandwidth reserved for each of their four traffic categories. Please note that the combined percentage value of transmission limits does not have to be 100%. These percentages represent the maximum bandwidth designated for each traffic category.

Ethernet to Wireless: The value entered here indicates the Ethernet to wireless speed required before the Advanced QoS function is enabled. Advanced QoS will be enabled once the total bandwidth reaches or surpasses the set value. The suggested range is 800 ~ 96000kbits/sec.

Wireless to Ethernet: The value entered here indicates the wireless to Ethernet speed required before the Advanced QoS function is enabled. Advanced QoS will be enabled once the total bandwidth reaches or surpasses the set value. The suggested range is 800 ~ 96000kbits/sec.

ACK/DHCP/ICMP/DNS Priority: Represents the priority value and bandwidth limit applied to ACK, DHCP, ICMP, and DNS for packet delivering.

Web Traffic Priority: Traffic generated by typical Web services (packets sent through ports 80,443, 3128 and 8080).

Mail Traffic Priority: Traffic generated by e-mail sending and receiving (ports 25, 110, 465 and 995).

Ftp Traffic Priority: Traffic generated by FTP Uploading and Downloading (ports 20, 21).

Other Traffic Priority: Other traffic generated that does not regard the aforementioned packet delivery.

Note: Normally the wireless connection transmits application data packets based on the wireless to Ethernet speed and Ethernet to wireless speed. Users can treat the two speeds as system transmission bandwidth, where all applications will share the whole system bandwidth based on assigned priorities. Note that the maximum amount of bandwidth that can be used is the same as the set value of both speeds.

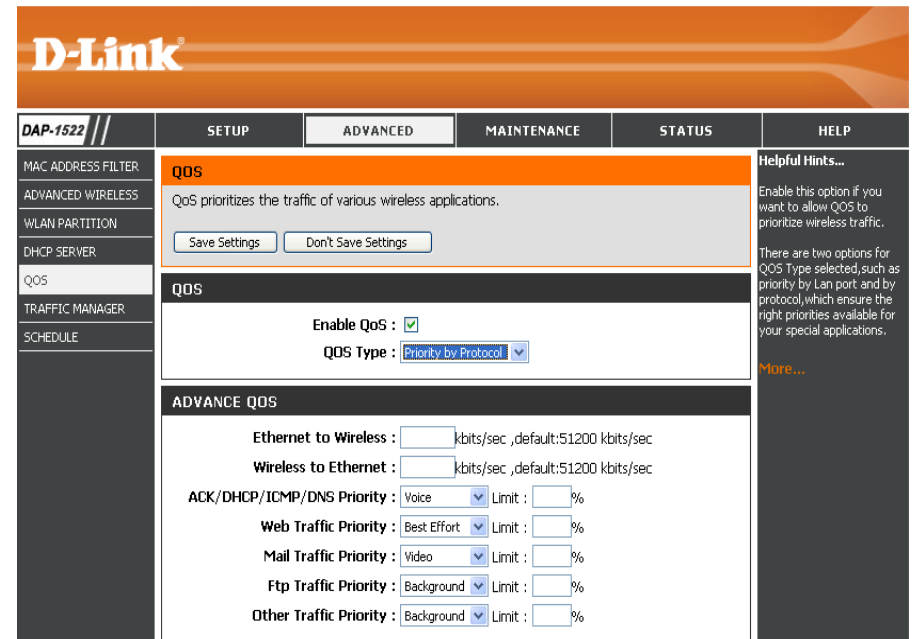

Traffic Manager

Traffic Manager assigns the device's entire bandwidth, which includes both the wireless to Ethernet speed and Ethernet to wireless speed. The user may add rules for data transmission performance between the access point device and the individual client. For unlisted client traffic, users can either choose to deny or forward packet transferred for such clients.

Enable Traffic Manager: Traffic Manager enables traffic control of the delivering and receiving of data packets.

Unlisted Clients Traffic: There are two options available for Unlisted Clients Traffic: (1) deny, and (2) forward.

Ethernet to Wireless: This section allows the user to indicate the device's maximum bandwidth from Ethernet to wireless.

Wireless to Ethernet: This section allows the user to indicate the device's maximum bandwidth from wireless to Ethernet.

The screenshot shows the D-Link DAP-1522 web interface. The top navigation bar includes 'D-Link', 'DAP-1522', and tabs for 'SETUP', 'ADVANCED', 'MAINTENANCE', 'STATUS', and 'HELP'. The 'ADVANCED' tab is selected, and the 'TRAFFIC MANAGER' section is active.

TRAFFIC MANAGER

Traffic Manager gives you control of your network traffic, increasing the efficiency of your network and reducing your overall bandwidth requirements .

Save Settings Don't Save Settings

TRAFFIC MANAGER

Traffic Manager : Enable Disable

Unlisted Clients Traffic : Deny Forward

Ethernet to Wireless : kbits/sec ,default:51200 kbits/sec

Wireless to Ethernet : kbits/sec ,default:51200 kbits/sec

ADD TRAFFIC MANAGER RULE

Name :

Client IP(optional):

Client MAC(optional):

Ethernet to Wireless : kbits/sec

Wireless to Ethernet : kbits/sec

Add Clear

TRAFFIC MANAGER RULES

Name	Client Ip	Client Mac	Ethernet to Wireless Speed	Wireless to Ethernet Speed	Edit Del

WIRELESS

Helpful Hints...

Enable this option if you want to allow TRAFFIC MANAGER to control wireless traffic speed.

For most applications, the traffic manager ensure the right traffic speed and specific traffic manager rules are not required.

More...

Add Traffic Manager Rule

In Traffic Manager Rule enter settings for each user of your network, using adequate IP (Client IP) or MAC address (Client MAC). Set appropriate Ethernet to Wireless and Wireless to Ethernet speeds for the traffic you want to regulate.

Name: Enter a name for your new rule.

Client IP (optional): The IP address assigned to the client.

Client MAC (optional) : By assigning MAC addresses to the set of traffic manager rules, specific rules can be defined for individual devices.

Ethernet to Wireless: Represents the available bandwidth for client data to be forwarded from Ethernet to wireless, the suggested range is 800 ~ 96000kbits/sec.

Wireless to Ethernet: Represents the available bandwidth for client data to be forwarded from wireless to Ethernet, the suggested range is 800 ~ 96000kbits/sec.

Note: Normally the wireless connection transmits application data packets based on the wireless to Ethernet speed and Ethernet to wireless speed. Users can treat the two speeds as system transmission bandwidth, where all applications will share the whole system bandwidth based on assigned priorities. Note that the maximum amount of bandwidth that can be used is the same as the set value of both speeds.

Schedule

Name: Enter a name for your new schedule.

Days: Select a day, a range of days, or All Week to include every day.

Time: Check **All Days** or enter a start and end time for your schedule.

Wireless: Select **On** or **Off** from the drop-down menu.

Add: Click **Add** to save your schedule. You must click **Save Settings** at the top for your schedules to go into effect.

Schedule Rules The list of schedules will be listed here. Click the **List:** **Edit** icon to make changes or click the **Delete** icon to remove the schedule.

The screenshot shows the D-Link DAP-1522 web interface. The top navigation bar includes 'D-Link', 'DAP-1522', and tabs for 'SETUP', 'ADVANCED', 'MAINTENANCE', 'STATUS', and 'HELP'. The left sidebar lists configuration options: 'MAC ADDRESS FILTER', 'ADVANCED WIRELESS', 'WLAN PARTITION', 'DHCP SERVER', 'QOS', 'TRAFFIC MANAGER', and 'SCHEDULE'. The main content area is titled 'WIRELESS SCHEDULE SETTINGS' and contains a 'Save Settings' button and a 'Don't Save Settings' button. Below this, the 'Wireless Schedule' is set to 'Disable'. The 'ADD SCHEDULE RULE' section includes a 'Name' field, 'Day(s)' options (All Week, Select Day(s)), checkboxes for days of the week, an 'All Day(s)' checkbox, 'Start Time' and 'End Time' fields (hour:minute, 24 hour time), and a 'Wireless' dropdown menu set to 'Off'. 'Add' and 'Clear' buttons are at the bottom right of this section. Below the 'ADD SCHEDULE RULE' section is a 'SCHEDULE RULE LIST' table with columns for 'Name', 'Day(s)', 'Time Frame', 'Wireless', and 'Edit Delete'. The bottom of the page features a 'WIRELESS' banner.

Maintenance

Admin

This page will allow you to change the Administrator password. The administrator password has read/write access.

Password: Enter a new password for the Administrator Login Name. The administrator can make changes to the settings.

Verify Password: Enter the same password that you entered in the previous textbox in order to confirm its accuracy.

The screenshot shows the D-Link DAP-1522 web interface. The top navigation bar includes 'D-Link' logo and tabs for 'DAP-1522', 'SETUP', 'ADVANCED', 'MAINTENANCE', 'STATUS', and 'HELP'. The 'MAINTENANCE' tab is selected. On the left, a sidebar menu lists 'ADMIN', 'TIME', 'SYSTEM', and 'FIRMWARE'. The main content area is titled 'ADMINISTRATOR SETTINGS' and contains the following text: 'The 'admin' accounts can access the management interface. The admin has read/write access and can change passwords.' and 'By default there is no password configured. It is highly recommended that you create a password to keep your access point secure.' Below this text are two buttons: 'Save Settings' and 'Don't Save Settings'. The 'ADMIN PASSWORD' section below it says 'Please enter the same password into both boxes, for confirmation.' and features two password input fields labeled 'Password' and 'Verify Password'. On the right side, there is a 'Helpful Hints...' section with text: 'For security reasons, it is recommended that you change the password for the Admin. Be sure to write down the new passwords to avoid having to reset the access point in case they are forgotten.' and a 'More...' link.

Time

The Time Configuration option allows you to configure, update, and maintain the correct time on the internal system clock. From this section you can set the time zone that you are in. Daylight Saving can also be configured to automatically adjust the time when needed.

Time Zone: Select the Time Zone from the drop-down menu.

Daylight Saving: To select Daylight Saving time manually, tick the Enable Daylight Saving check box. Next use the drop-down menu to select a Daylight Saving Offset and then enter a start date and an end date for daylight saving time.

Enable NTP Server: NTP is short for Network Time Protocol. NTP synchronizes computer clock times in a network of computers. Check this box to use a NTP server. This will only connect to a server on the Internet, not a local server.

NTP Server Used: Enter the NTP server or select one from the drop-down menu.

Manual: To manually input the time, enter the values in these fields for the Year, Month, Day, Hour, Minute, and Second and then click **Save Settings**. You can also click the **Copy Your Computer's Time Settings** button at the bottom of the screen.

The screenshot shows the D-Link web interface for the DAP-1522 device. The main navigation bar includes 'DAP-1522', 'SETUP', 'ADVANCED', 'MAINTENANCE', 'STATUS', and 'HELP'. The left sidebar lists 'ADMIN', 'TIME', 'SYSTEM', and 'FIRMWARE'. The 'TIME' section is active, displaying the following configuration options:

- TIME CONFIGURATION:**
 - Time: 01/01/2000 00:36:20
 - Time Zone: (GMT-08:00) Pacific Time (US & Canada); Tijuana
 - Enable Daylight Saving:
 - Daylight Saving Offset: +1:00
 - Daylight Saving Dates:

	Month	Week	Day of Week	Time
DST Start	Jan	1st	Sun	12 am
DST End	Jan	1st	Sun	12 am
- AUTOMATIC TIME CONFIGURATION:**
 - Enable NTP server:
 - NTP Server: [] << Select NTP Server
- SET THE DATE AND TIME MANUALLY:**
 - Date And Time: Year: 2009, Month: Jul, Day: 16, Hour: 6, Minute: 43, Second: 44, PM
 - Copy Your Computer's Time Settings

Buttons for 'Save Settings' and 'Don't Save Settings' are located at the top of the configuration area. A 'Helpful Hints...' sidebar on the right contains the text: 'Good timekeeping is important for accurate logs. More...'

System

Save to Local Hard Drive: Use this option to save the current access point configuration settings to a file on the hard disk of the computer you are using. First, click the **Save** button. You will then see a file dialog, where you can select a location and file name for the settings.

Load from Local Hard Drive: Use this option to load previously saved access point configuration settings. First, use the Browse control to find a previously save file of configuration settings. Then, click the **Load** button to transfer those settings to the access point.

Restore to Factory Default: This option will restore all configuration settings back to the settings that were in effect at the time the access point was shipped from the factory. Any settings that have not been saved will be lost, including any rules that you have created. If you want to save the current access point configuration settings, use the **Save** button above.

Note: Restoring the factory default settings will not reset the Wi-Fi Protected Status to Not Configured.

Reboot the Device: Click to reboot the access point.

Clear Language Pack: Click to clear the language pack. This will put the web UI back to English.

The screenshot shows the D-Link DAP-1522 web interface. The top navigation bar includes tabs for SETUP, ADVANCED, MAINTENANCE, STATUS, and HELP. The left sidebar contains menu items for ADMIN, TIME, SYSTEM, and FIRMWARE. The main content area is titled 'SYSTEM SETTINGS' and contains the following options:

- Save To Local Hard Drive :** Save Configuration
- Load From Local Hard Drive :** [Browse...] Restore Configuration from File
- Restore To Factory Default :** Restore Factory Defaults
Restore all settings to the factory defaults.
- Reboot The Device :** Reboot the Device

Helpful Hints...
Once your access point is configured the way you want it, you can save the configuration settings to a configuration file.
You might need this file so that you can load your configuration later in the event that the access point's default settings are restored.
To save the configuration, click the "Save Configuration" button.
More...

Firmware

You can upgrade the firmware of the access point here. Make sure the firmware you want to use is on the local hard drive of the computer. Click on **Browse** to locate the firmware file to be used for the update. Please check the D-Link support website for firmware updates at <http://support.dlink.com>. You can download firmware upgrades to your hard drive from this site.

Browse: After you have downloaded the new firmware, click Browse to locate the firmware update on your hard drive. Click **Upload** to complete the firmware upgrade.

Upload: Once you have a firmware update on your computer, use this option to browse for the file and then upload the information into the access point.

Language Pack

You can change the language of the web UI by uploading available language packs.

Browse: After you have downloaded the new language pack, click **Browse** to locate the language pack file on your hard drive. Click **Upload** to complete the language pack upgrade.

The screenshot displays the D-Link web interface for a DAP-1522 access point. The top navigation bar includes tabs for SETUP, ADVANCED, MAINTENANCE (which is active), STATUS, and HELP. The left sidebar shows a menu with ADMIN, TIME, SYSTEM, and FIRMWARE (which is selected). The main content area is titled 'FIRMWARE' and contains the following sections:

- FIRMWARE INFORMATION:** Shows 'Current Firmware Version : 1.21' and 'Current Firmware Date : 09:31:38 06/04/2009'.
- FIRMWARE UPGRADE:** Includes a red note: 'Note: Some firmware upgrades reset the configuration options to the factory defaults. Before performing an upgrade, be sure to save the current configuration from the Maintenance -> Admin screen.' Below this, instructions state: 'To upgrade the firmware, your PC must have a wired connection to the access point. Enter the name of the firmware upgrade file, and click on the Upload button.' There is an 'Upload' field with a 'Browse...' button and an 'Upload' button.
- LANGUAGE PACKAGE INFORMATION:** Includes a red note: 'Note: Update language package will make changes language display on web page. Before performing an upgrade, be sure to do it!' Below this, instructions state: 'To upgrade the language package, your PC must have a wired connection to the access point. Enter the name of the language package upgrade file, and click on the Upload button.' There is an 'Upload' field with a 'Browse...' button and an 'Upload' button.

On the right side of the interface, there is a 'Helpful Hints...' section with text: 'Firmware updates are released periodically to improve the functionality of your access point and to add features. If you run into a problem with a specific feature of the access point, check our support site by clicking the "Click here to check for an upgrade on our support site" link and see if updated firmware is available for your access point.' Below this is a 'More...' link. The bottom of the page features the 'WIRELESS' logo.

If you load a language pack and would like to go back to English, click **Maintenance > System** and click on **Clear** next to **Clear Language Pack**.

DAP-1522 //	SETUP	ERWEITERT	WARTUNG	STATUS	HILFE
ADMIN	SYSTEMEINSTELLUNGEN				<p>Nützliche Hinweise...</p> <p>Sobald Ihr Access Point wie gewünscht konfiguriert ist, können Sie die Konfigurationseinstellungen in einer Konfigurationsdatei speichern.</p> <p>Sie benötigen diese Datei möglicherweise, damit Sie Ihre Konfiguration später laden können, falls die Standardeinstellungen des Access Point wiederhergestellt wurden.</p> <p>Klicken Sie auf die Schaltfläche "Konfiguration speichern", um die Konfiguration zu speichern.</p> <p>Mehr...</p>
ZEIT	<p>Im Abschnitt "Systemeinstellungen" können Sie das Gerät neu starten oder den Access Point auf die Werkseinstellungen zurücksetzen. Wenn das Gerät auf die Werkseinstellungen zurückgesetzt wird, werden alle Einstellungen, einschließlich aller von Ihnen erstellten Regeln, gelöscht.</p> <p>Die aktuellen Systemeinstellungen können als Datei auf der lokalen Festplatte gespeichert werden. Die gespeicherte Datei oder eine andere vom Gerät erstellte, gespeicherte Einstellungsdatei kann in das Gerät geladen werden.</p>				
SYSTEM	<p>Auf der lokalen Festplatte speichern : <input type="button" value="Konfiguration speichern"/></p> <p>Von der lokalen Festplatte laden : <input type="text"/> <input type="button" value="Browse..."/> <input type="button" value="Konfiguration von Datei wiederherstellen"/></p> <p>Auf Werkseinstellungen zurücksetzen : <input type="button" value="Werkseinstellungen wiederherstellen"/> Alle Einstellungen auf die Werkseinstellungen zurücksetzen.</p> <p>Starten Sie das Gerät neu : <input type="button" value="Starten Sie das Gerät neu"/></p>				
FIRMWARE	<p>Sprachpaket löschen: <input type="button" value="Entfernen"/></p>				

DAP-1522 //	CONFIGURACIÓN	AVANZADO	MANTENIMIENTO	ESTADO	AYUDA
ADMINISTRADOR	PARÁMETROS DEL SISTEMA				<p>Sugerencias útiles...</p> <p>Una vez que el punto de acceso está configurado como lo desea, puede guardar los parámetros de configuración en un archivo de configuración.</p> <p>Puede que necesite este archivo para poder cargar la configuración más adelante en el caso de que se restablezcan los parámetros predeterminados del punto de acceso.</p> <p>Para guardar la configuración, haga clic en el botón "Guardar configuración".</p> <p>Más información...</p>
HORA	<p>La sección Parámetros del sistema le permite reiniciar el dispositivo o restaurar el punto de acceso a los parámetros predeterminados de fábrica. Al restaurar en la unidad los parámetros predeterminados de fábrica se borrarán todos los parámetros, incluidas las reglas que haya creado.</p> <p>Se pueden guardar los parámetros del sistema actual como un archivo en la unidad de disco duro local. Puede cargarse en la unidad el archivo guardado o cualquier otro archivo de parámetros guardado creado por el dispositivo.</p>				
SISTEMA	<p>Guardar en la unidad de disco duro local : <input type="button" value="Guardar configuración"/></p> <p>Cargar desde la unidad de disco duro local : <input type="text"/> <input type="button" value="Browse..."/> <input type="button" value="Restablecer la configuración del archivo"/></p> <p>Restablecer en los valores predeterminados de fábrica : <input type="button" value="Restablecer valores predeterminados de fábrica"/> Restablecer todos los parámetros en los valores predeterminados de fábrica.</p> <p>Reinicie el dispositivo : <input type="button" value="Reiniciar el dispositivo"/></p>				
FIRMWARE	<p>Borrar paquete de idioma: <input type="button" value="Borrar"/></p>				

DAP-1522 //	CONFIGURATION	AVANÇÉ	MAINTENANCE	ÉTAT	AIDE
ADMIN	PARAMÈTRES SYSTÈME				<p>Conseils utiles...</p> <p>Une fois le point d'accès configuré comme vous le souhaitez, vous pouvez enregistrer les paramètres de configuration dans un fichier de configuration.</p> <p>Vous aurez peut-être besoin de ce fichier pour charger votre configuration ultérieurement, en cas de restauration des paramètres par défaut de votre point d'accès.</p> <p>Pour enregistrer la configuration, cliquez sur le bouton "Enregistrer la configuration".</p> <p>Plus...</p>
HEURE	<p>La section Configuration du système vous permet de réinitialiser le périphérique ou de restaurer les paramètres d'usine point d'accès. Restaurer les valeurs d'usine de tous les paramètres efface tous vos paramètres, y compris toutes les règles que vous avez créées.</p> <p>La configuration actuelle du système peut être enregistrée sous forme de fichier sur le disque dur local. Le fichier enregistré ou tout autre fichier de configuration enregistré et créé par le périphérique peut être chargé sur la machine.</p>				
SYSTÈME	<p>Enregistrer sur le disque dur local : <input type="button" value="Enregistrer la configuration"/></p> <p>Charger depuis le disque dur local : <input type="text"/> <input type="button" value="Browse..."/> <input type="button" value="Restaurer la configuration à partir d'un fichier"/></p> <p>Restaurer les paramètres par défaut : <input type="button" value="Restaurer les valeurs d'usine"/> Restaurer tous les paramètres sur les valeurs définies à l'usine.</p> <p>Réinitialiser le périphérique : <input type="button" value="Réinitialiser le périphérique"/></p>				
MICROPROGRAMME	<p>Effacer le pack linguistique : <input type="button" value="Effacer"/></p>				

DAP-1522 //	CONFIGURAZIONE	AVANZATE	MANUTENZIONE	STATO	GUIDA
ADMIN	IMPOSTAZIONI SISTEMA				<p>Suggerimenti utili...</p> <p>Dopo aver configurato il punto di accesso in modo desiderato, è possibile salvare le impostazioni in un apposito file di configurazione.</p> <p>Tale file potrebbe essere necessario per caricare la configurazione in un secondo momento qualora venissero ripristinate le impostazioni predefinite del punto di accesso.</p> <p>Per salvare la configurazione, fare clic sul pulsante "Salva configurazione".</p> <p>Altro...</p>
ORA	<p>La sezione Impostazioni sistema consente di riavviare il dispositivo o di ripristinare le impostazioni predefinite del punto di accesso. Il ripristino delle impostazioni predefinite comporta la cancellazione di tutte le impostazioni precedenti, incluse eventuali regole create dall'utente.</p> <p>È possibile salvare le impostazioni di sistema correnti in un file del disco fisso locale. Il file salvato o qualsiasi altro file di impostazioni salvato creato dal dispositivo può quindi essere caricato nell'unità.</p>				
SISTEMA	<p>Salva su Disco fisso locale : <input type="button" value="Salva configurazione"/></p> <p>Carica da disco fisso locale : <input type="text"/> <input type="button" value="Browse..."/> <input type="button" value="Ripristina configurazione da file"/></p> <p>Ripristina impostazioni predefinite : <input type="button" value="Ripristina impostazioni predefinite"/> Ripristina tutte le impostazioni predefinite.</p> <p>Riavvio del dispositivo : <input type="button" value="Riavvio del dispositivo"/></p>				
FIRMWARE	<p>Cancela Language Pack: <input type="button" value="Cancella"/></p>				

Status

Device Info

This page displays the current information for the DAP-1522. It will display the LAN and wireless LAN information.

General: Displays the access point's time and firmware version.

LAN: Displays the MAC address and the private (local) IP settings for the access point.

Wireless LAN: Displays the wireless MAC address and your wireless settings such as SSID and Channel.

D-Link	
DAP-1522	STATUS
<p>DEVICE INFO</p> <p>WIRELESS</p> <p>LOGS</p> <p>STATISTICS</p>	<p>DEVICE INFORMATION</p> <p>All of your network connection details are displayed on this page. The firmware version is also displayed here.</p> <p>GENERAL</p> <p>Firmware Version : 1.21 , Thu 04 Jun 2009</p> <p>LAN</p> <p>Connection Type : Static IP</p> <p>MAC Address : 00:22:b0:73:50:5f</p> <p>IP Address : 192.168.0.50</p> <p>Subnet Mask : 255.255.255.0</p> <p>Default Gateway :</p> <p>WIRELESS LAN</p> <p>Wireless Radio : Enabled</p> <p>MAC Address : 00:22:b0:73:50:5f</p> <p>Network Name(SSID) : dlink</p> <p>Channel : 1</p> <p>Security Type : WPA-Auto- Personal / Auto</p> <p>Wi-Fi Protected Setup : Enabled / Configured</p>

Helpful Hints...
All of your LAN and WLAN connection details are displayed here.
More...

WIRELESS

Wireless

The wireless section allows you to view the wireless clients that are connected to your wireless access point.

MAC Address: The Ethernet ID (MAC address) of the wireless client.

UpTime: Displays the amount of time the wireless client has been connected to the access point.

Mode: The transmission standard being used by the client. Values are 11a, 11b, 11g, 11ng or 11na for 802.11a, 802.11b, 802.11g or 802.11n respectively.

Signal: This is a relative measure of signal quality. The value is expressed as a percentage of theoretical best quality. Signal quality can be reduced by distance, by interference from other radio-frequency sources (such as cordless telephones or neighboring wireless networks), and by obstacles between the access point and the wireless device.

D-Link									
DAP-1522 //	SETUP ADVANCED MAINTENANCE STATUS HELP								
DEVICE INFO	WIRELESS								
WIRELESS	View the wireless clients that are connected to your access point.								
LOGS	NUMBER OF WIRELESS CLIENTS : 0								
STATISTICS	<table border="1"> <thead> <tr> <th>MAC Address</th> <th>UpTime</th> <th>Mode</th> <th>Signal (%)</th> </tr> </thead> <tbody> <tr> <td colspan="4"> </td> </tr> </tbody> </table>	MAC Address	UpTime	Mode	Signal (%)				
MAC Address	UpTime	Mode	Signal (%)						
	<p>Helpful Hints...</p> <p>This is a list of all wireless clients that are currently connected to your access point.</p> <p>More...</p>								

Logs

The access point automatically logs (records) events of possible interest in its internal memory. If there isn't enough internal memory for all events, logs of older events are deleted, but logs of the latest events are retained. The Logs option allows you to view the access point logs. You can define what types of events you want to view and the level of the events to view. This access point also has external Syslog Server support so you can send the log files to a computer on your network that is running a Syslog utility

What to View: There are three types of logs that can be viewed: **System Activity**, **Wireless Activity**, and **Notice**. Tick the corresponding check box for the type(s) that you want displayed in the log.

Enable Remote Log: Select the check box and enter a Log Server name or IP address to enable the remote log feature.

Apply Log Settings Now: Click this button to immediately filter the log results so that only the selected options appear in the Log Details section of this screen.

Refresh: Updates the log details on the screen so it displays any recent activity.

Clear: Clear all of the log contents.

Save Log: This option will save the access point to a log file on your computer.

D-Link

DAP-1522 // SETUP ADVANCED MAINTENANCE STATUS HELP

LOGS
View the logs. You can define the event levels to view.

LOG OPTIONS

What to View : System Activity Wireless Activity Notice

Enable Remote Log : Log Server / IP Address :

Apply Log Settings Now

LOG DETAILS

First Page Last Page Previous Next Clear Refresh Save Log

Page 1 of 2

Time	Priority	Message
Uptime 0 day 00:27:27	[SYSACT]	Web login success from 192.168.0.100
Uptime 0 day 00:26:40	[SYSACT]	Web logout from 192.168.0.100
Uptime 0 day 00:23:39	[SYSACT]	Web login success from 192.168.0.100
Uptime 0 day 00:23:34	[SYSACT]	Web logout from 192.168.0.100
Uptime 0 day 00:20:20	[Wireless]	Initiate Wireless success
Uptime 0 day 00:20:20	[Wireless]	Auto channel:Best channel is 1
Uptime 0 day 00:20:13	[Wireless]	Stop Wireless success
Uptime 0 day 00:06:21	[SYSACT]	Web login success from 192.168.0.100
Uptime 0 day 00:06:15	[SYSACT]	Web logout from 192.168.0.100
Uptime 0 day 00:01:49	[SYSACT]	Web login success from 192.168.0.100

WIRELESS

Helpful Hints...
Check the log frequently to detect unauthorized network usage.
More...

Statistics

The Statistics page displays all of the LAN and Wireless packets transmit and receive statistics.

TX Packets: The total number of packets sent from the access point.

RX Packets: The total number of packets received by the access point.

TX Packets Dropped: Displays the number of packets that were dropped while sending, due to errors, collisions, or access point resource limitations.

RX Packets Dropped: Displays the number of packets that were dropped while receiving, due to errors, collisions, or access point resource limitations.

TX Bytes: Displays the number of bytes that were sent from the access point.

RX Bytes: Displays the number of bytes that were received by the access point.

The screenshot shows the D-Link web interface for the DAP-1522 device. The top navigation bar includes tabs for SETUP, ADVANCED, MAINTENANCE, STATUS, and HELP. The left sidebar contains links for DEVICE INFO, WIRELESS, LOGS, and STATISTICS. The main content area is titled 'TRAFFIC STATISTICS' and includes a description: 'Traffic Statistics display receive and transmit packets passing through your access point.' Below this are two buttons: 'Refresh Statistics' and 'Clear Statistics'. The statistics are organized into three sections: LAN STATISTICS, WIRELESS STATISTICS, and a 'Helpful Hints...' section on the right.

LAN STATISTICS	
TX Packet Numbers : 2355	RX Packet Numbers : 1666
TX Packets Dropped : 0	RX Packets Dropped : 0
TX Packets Bytes : 2787099	RX Packets Bytes : 132344

WIRELESS STATISTICS	
TX Packet Numbers : 16	RX Packet Numbers : 32636
TX Packets Dropped : 0	RX Packets Dropped : 0
TX Packets Bytes : 2170	RX Packets Bytes : 6753158

Helpful Hints...
This is a summary of the number of packets that have passed between the WAN and the LAN since the access point was last initialized.
[More...](#)

Help

The screenshot shows the D-Link web interface for the DAP-1522 device. At the top left is the D-Link logo. Below it is a navigation bar with tabs for SETUP, ADVANCED, MAINTENANCE, STATUS, and HELP. The HELP tab is selected. On the left side, there is a vertical menu with options: MENU, SETUP, ADVANCED, MAINTENANCE, and STATUS. The main content area is titled 'SUPPORT MENU' and contains three sections of help links: Setup Help, Advanced Help, Maintenance Help, and Status Help. A 'Helpful Hints...' section is partially visible on the right.

D-Link®

DAP-1522 //

SETUP ADVANCED MAINTENANCE STATUS **HELP**

MENU
SETUP
ADVANCED
MAINTENANCE
STATUS

SUPPORT MENU

Setup Help

- [Wireless Settings](#)
- [Network Settings](#)

Advanced Help

- [MAC Address Filter](#)
- [Advanced Wireless](#)
- [WLAN Partition](#)
- [DHCP Server](#)
- [QoS](#)
- [Traffic Manager](#)
- [Schedule](#)

Maintenance Help

- [Admin](#)
- [Time](#)
- [System](#)
- [Firmware](#)

Status Help

- [Device Info](#)
- [Wireless](#)
- [Logs](#)
- [Statistics](#)

Helpful Hints...

Configuration for Bridge Mode

This section will show you how to configure your new D-Link wireless MediaBridge using the web-based configuration utility.

Web-based Configuration Utility

To access the configuration utility, open a web-browser such as Internet Explorer and enter dlinkap or enter 192.168.0.50 in the address field.

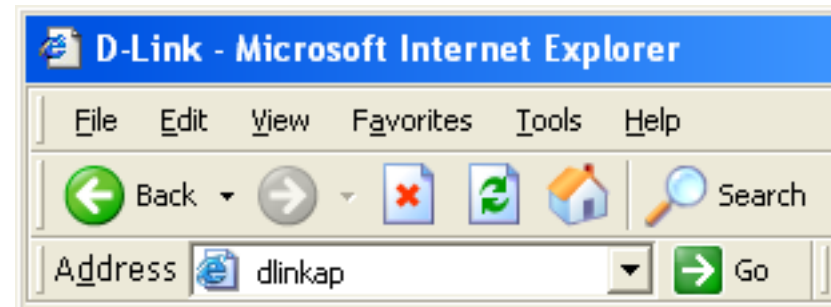

Select **Admin** from the drop-down menu and then enter your password. Leave the password blank by default.

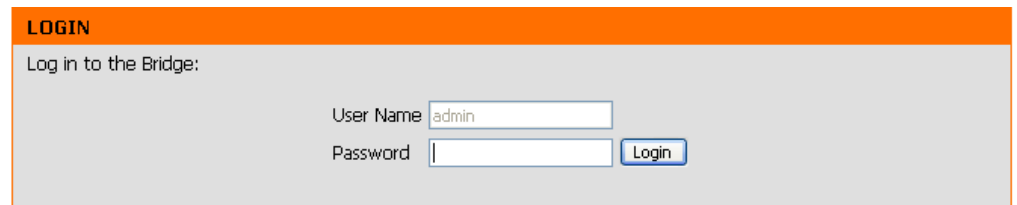

If you get a Page Cannot be Displayed error, please refer to the Troubleshooting section for assistance.

Setup Wizard

This wizard is designed to assist you in configuring the wireless settings for your bridge. It will guide you through step-by-step instructions on how to setup your wireless network.

The screenshot shows the D-Link web interface for the DAP-1522. The top navigation bar includes 'D-Link', 'DAP-1522', and tabs for 'SETUP', 'ADVANCED', 'MAINTENANCE', 'STATUS', and 'HELP'. The left sidebar has a tree view with 'WIZARD', 'WIRELESS', and 'NETWORK SETTINGS'. The main content area displays the 'MICROSOFT WINDOWS CONNECT NOW WIZARD' with the following text:

The following Web-based Setup Wizard is designed to assist you in your wireless network setup. This Setup Wizard will guide you through step-by-step instructions on how to set up your wireless network and how to make it secure.

Note: Some changes made using this Setup Wizard may require you to change some settings on your wireless client adapters so they can still connect to the D-Link Access Point.

A 'Launch Wireless Setup Wizard' button is visible. A callout box on the left contains the text 'Click Launch Wireless Setup Wizard' with an arrow pointing to the button.

Helpful Hints..
If you are new to wireless networking and have never configured a wireless bridge before, click on Wireless Setup Wizard and the bridge will guide you through a few simple steps to setup your wireless network.
More...

Enter the Device Name of the AP and click **Next** to continue. It is recommended to change the Device Name if there is more than one D-Link device within the subnet.

The screenshot shows the 'SET YOUR DEVICE NAME' configuration page. The text reads: 'Enter the Device Name of the AP. Recommend to change the Device Name if there're more than one D-Link devices within the subnet. Click **Next** to continue.'

The 'Device Name (NetBIOS Name)' field contains the text 'dlinkap'. Below the field are 'Next' and 'Exit' buttons.

If you want to change the admin account password, enter a new password and click **Next**.

SET YOUR NEW PASSWORD

You may change the **admin** account password by entering in a new password. Click **Next** to continue.

Password : [mask]

Verify Password : [mask]

Prev Next Exit

Select **Auto** configuration if you want to use Wi-Fi Protected Setup.

If you want to set up your network manually, skip to page 53.

Click **Next** to continue.

SELECT CONFIGURATION METHOD

Please select one of the following configuration methods and click next to continue.

Auto (Select this option if you want to use Wi-Fi Protected Setup)

Manual (Select this option if you want to setup your network manually)

Prev Next Exit

Select **PIN** to connect your wireless device with WPS.

For **PBC** configuration, skip to page 52.

Enter the **PIN** number used into you access point and click Connect.

CONNECT TO WIRELESS DEVICE WITH WPS

There are two ways to add wireless device to your wireless network:

- PIN (Personal Identification Numner)
- PBC (Push Button Configuration)

PIN : 12345678

Please Enter the above PIN information into your Acces Point and click the below "Connect" button.

PBC

Please press the push button on your wireless device and press the "Connect" button below within 120 seconds

Start WPS on the wireless device you are adding to you wireless network to complete the setup.

USING PIN NUMBER

Please start WPS on the wireless device you are adding to your wireless network within **118** seconds ...

Select **PBC** to use the Push Button Configuration to connect to your network.

Click **Connect** to continue.

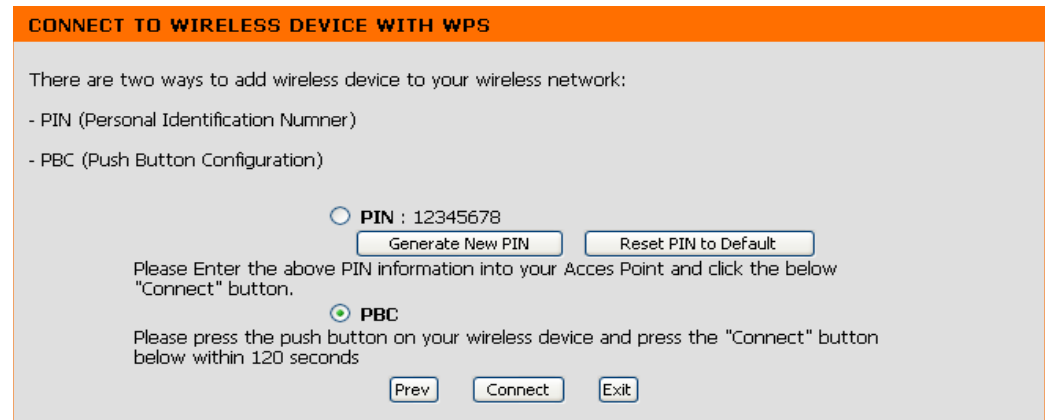

CONNECT TO WIRELESS DEVICE WITH WPS

There are two ways to add wireless device to your wireless network:

- PIN (Personal Identification Nummer)
- PBC (Push Button Configuration)

PIN : 12345678
Generate New PIN Reset PIN to Default

Please Enter the above PIN information into your Acces Point and click the below "Connect" button.

PBC
Please press the push button on your wireless device and press the "Connect" button below within 120 seconds

Prev Connect Exit

Press down the WPS Button on the wireless device you are adding to your network to complete the setup.

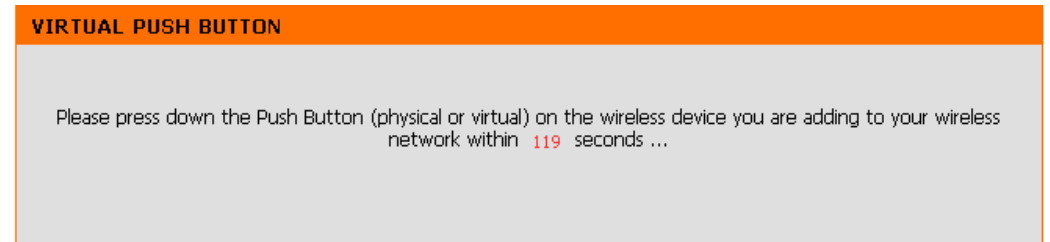

VIRTUAL PUSH BUTTON

Please press down the Push Button (physical or virtual) on the wireless device you are adding to your wireless network within 119 seconds ...

Select **Manual** configuration to set up your network manually.

Click **Next** to continue.



SELECT CONFIGURATION METHOD

Please select one of the following configuration methods and click next to continue.

- Auto** (Select this option if you want to use Wi-Fi Protected Setup)
- Manual** (Select this option if you want to setup your network manually)

Prev Next Exit

Enter the **Wireless Network Name** of the AP or click the Site Survey button to find the AP.

Click **Next** to continue on to page 54.

SET WIRELESS NETWORK NAME

You can enter the Wireless Network Name of AP or use site survey to find the AP.

Wireless Network Name (SSID)

If you clicked on **Site Survey**, the following screen will be displayed.

Find your access point from the list and click **Connect** to complete the Setup Wizard.

SITE SURVEY PAGE

SSID	BSSID	CH	Security	Signal	Type	
7700_11g	00:50:62:35:97:30	1	WPA-PSK	50%	Infrastructure	<input type="radio"/>
dlinkmargg	00:1D:6A:12:0F:82	1	WPA-AUTO-PSK	50%	Infrastructure	<input type="radio"/>
dlink	00:17:9A:36:47:9C	1	OPEN	50%	Infrastructure	<input type="radio"/>
D-Link DVA-G3672B	00:50:BA:11:22:3D	1	OPEN	68%	Infrastructure	<input type="radio"/>
12345678901234567890123456789012	00:18:02:1B:87:96	3	OPEN	52%	Infrastructure	<input type="radio"/>
AlexDI524	00:13:46:A1:A4:0A	4	SHARED	50%	Infrastructure	<input type="radio"/>
james54g	00:13:46:E5:3C:72	6	WPA-EAP	50%	Infrastructure	<input type="radio"/>
di624s	00:17:9A:CF:96:0C	6	SHARED	54%	Infrastructure	<input type="radio"/>
dlink EC	00:0F:3D:3D:90:0E	6	WPA-PSK	50%	Infrastructure	<input type="radio"/>
default	00:55:19:06:24:01	6	OPEN	52%	Infrastructure	<input type="radio"/>
SD1VAPB0	00:11:95:95:CA:18	6	WPA-PSK	52%	Infrastructure	<input type="radio"/>
SD1VAPR1	06:11:95:95:CA:18	6	OPEN	50%	Infrastructure	<input type="radio"/>

Choose which Security Mode you want to use and click **Next** to continue.

SELECT WIRELESS SECURITY MODE

Please select the wireless security mode.

None

WEP

WPA

WPA2

If you choose **WEP**, enter the wireless security password and click **Next** to complete the Setup Wizard.

The screenshot shows a web interface with an orange header bar containing the text "SET YOUR WIRELESS SECURITY PASSWORD". Below the header, the text "Please enter the wireless password to establish wireless connection." is displayed. There are two input fields: "Password Type:" with a dropdown menu showing "64Bit (10 hex digits)" and "Password:" with a text box. At the bottom, there are three buttons: "Prev", "Next", and "Exit".

If you choose **WPA**, enter the **WPA** Personal Passphrase and click Next to complete the Setup Wizard.

The screenshot shows a web interface with an orange header bar containing the text "SET YOUR WIRELESS SECURITY PASSWORD". Below the header, the text "Please enter the wireless password to establish wireless connection." is displayed. There is one input field labeled "Password:" with a text box. At the bottom, there are three buttons: "Prev", "Next", and "Exit".

If you choose **WPA2**, enter the **WPA2** Personal Passphrase and click Next to complete the Setup Wizard.

The screenshot shows a web interface with an orange header bar containing the text "SET YOUR WIRELESS SECURITY PASSWORD". Below the header, the text "Please enter the wireless password to establish wireless connection." is displayed. There is one input field labeled "Password:" with a text box. At the bottom, there are three buttons: "Prev", "Next", and "Exit".

The following screen opens to indicate that you have successfully saved your new settings.



Wireless

Wireless Mode: Select Infrastructure to connect to a wireless (AP) Access Point, select Ad-hoc to connect to another bridge or wireless station.

Site Survey: A function that looks for available wireless networks.

Enable Wireless: Click the check box to enable the wireless function. If you do not want to use wireless, uncheck the box to disable all the wireless functions.

Wireless Network Name: Service Set Identifier (SSID) is the name of your wireless network. Create a name using up to 32 characters. The SSID is case-sensitive.

802.11 Band: The options include 2.4GHz, 5GHz, and 2.4GHz/5GHz. This option is unavailable in Bridge Mode.

802.11 Mode: If all of the wireless devices in your wireless network can connect in the same transmission mode, you can improve performance slightly by choosing the appropriate “Only” mode. If you have some devices that use a different transmission mode, choose the appropriate “Mixed” mode. This option is unavailable in Bridge Mode.

Enable Auto Channel Scan: The Auto Channel Scan setting is used to allow the DAP-1522 to choose the channel with the least amount of interference. This option is unavailable in Bridge Mode.

Wireless Channel: Indicates the channel setting for the DAP-1522. The Channel can be changed to fit the channel setting for an existing wireless network or to customize the wireless network. This option is unavailable in Bridge Mode.

D-Link

DAP-1522 // SETUP ADVANCED MAINTENANCE STATUS HELP

WIZARD WIRELESS NETWORK SETTINGS

WIRELESS NETWORK

Use this section to configure the wireless settings for your access point. Please note that changes made on this section may also need to be duplicated on your Wireless Client.

Save Settings Don't Save Settings

WIRELESS NETWORK SETTINGS

Wireless Mode : Bridge Mode Site Survey

Enable Wireless :

Wireless Network Name : dlink (Also called the SSID)

802.11 Band : 2.4GHz 5GHz 2.4GHz/5GHz

802.11 Mode : Mixed 802.11 abgn

Enable Auto Channel Scan :

Wireless Channel : 6

Transmission Rate : Best(automatic) (Mbit/s)

Channel Width : 20 MHz

Visibility Status : Visible Invisible

WIRELESS SECURITY MODE

Security Mode : Disable Wireless Security (not recommended)

WI-FI PROTECTED SETUP (ALSO CALLED WCN 2.0 IN WINDOWS VISTA)

Enable :

WIRELESS MAC CLONING

Enable :

MAC Source : Auto

MAC Address : : : : : :

Scan

Port MAC Address

WIRELESS

Helpful Hints...

Select the SSID which you want your bridge to connect to.

If you have enabled Wireless Security, make sure you write down the WEP Key or Passphrase that you have configured. You will need to enter this information on every wireless device that you connect to your wireless network.

More...

Transmission Rate: Select the transmit rate. It is strongly suggested to select Best (automatic) for best performance. This option is unavailable in Bridge Mode.

Channel Width: Select the Channel Width:

Auto 20/40 - Select if you are using both 802.11n and non-802.11n wireless devices.

20MHz - Select if you are not using any 802.11n wireless clients.

Visibility Status: This setting determines whether the DAP-1522 will continue to periodically broadcast its presence on the network. This option is unavailable in Bridge Mode.

Security Mode: Refer to page 65 for more information regarding wireless security.

Enable: Enable the Wi-Fi Protected Setup feature.

Wireless MAC Cloning

Enabling this option allows the user to manually assign the source MAC address to packets forwarded by the DAP-1522. If not manually assigned, the packet's source MAC address field will be automatically selected as the DAP-1522's MAC address.

MAC Address: Enter the desired MAC address connected to your DAP-1522 to enable the clone function.

Scan: Click the **Scan** button to search for all available devices connected to your DAP-1522's Ethernet ports

Network Settings

Static

This section will allow you to change the local network settings of the bridge and to configure the Static settings.

LAN Connection Type: Use the drop-down menu to select **Static IP** if your ISP assigned you the IP address, subnet mask, gateway, and DNS server addresses. Select **Dynamic IP (DHCP)** to automatically assign an IP address to the computers on the LAN/private network.

Access Point IP Address: Enter the IP address assigned by your ISP.

Subnet Mask: Enter the Subnet Mask assigned by your ISP.

Default Gateway: Enter the Gateway assigned by your ISP.

Device Name: Enter the Device Name of the AP and click **Next** to continue. It is recommended to change the Device Name if there is more than one D-Link device within the subnet.

D-Link

DAP-1522 // SETUP ADVANCED MAINTENANCE STATUS HELP

WIZARD
WIRELESS
NETWORK SETTINGS

NETWORK SETTINGS

Use this section to configure the internal network settings of your access point and also to configure the built-in DHCP Server to assign IP addresses to the computers on your network. The IP Address that is configured here is the IP Address that you use to access the Web-based management interface. If you change the IP Address here, you may need to adjust your PC's network settings to access the network again.

Save Settings Don't Save Settings

LAN SETTINGS

Use this section to configure the internal network settings of your access point. The IP Address that is configured here is the IP Address that you use to access the Web-based management interface. If you change the IP Address here, you may need to adjust your PC's network settings to access the network again.

LAN Connection Type : Static IP

Access Point IP Address : 192.168.0.50

Subnet Mask : 255.255.255.0

Default Gateway :

DEVICE NAME (NETBIOS NAME)

Device Name : dlinkap

Helpful Hints...
If you have a DHCP server on your network, you can select DHCP to get the IP address from a DHCP server.
More...

DHCP

LAN Connection Type: Select DHCP to automatically obtain an IP address on the LAN/private network.

Device Name: Enter the Device Name of the AP and click **Next** to continue. It is recommended to change the Device Name if there is more than one D-Link device within the subnet.

The screenshot shows the D-Link configuration web interface for a DAP-1555 device. The interface is divided into several sections:

- Header:** D-Link logo and navigation tabs: SETUP, ADVANCED, MAINTENANCE, STATUS, HELP.
- Left Sidebar:** A vertical menu with options: WIZARD, WIRELESS, and NETWORK SETTINGS (which is currently selected).
- Main Content Area:**
 - NETWORK SETTINGS:** A section with an orange header. It contains instructions: "Use this section to configure the internal network settings of your bridge and also to configure the built-in DHCP Server to assign IP addresses to the computers on your network. The IP Address that is configured here is the IP Address that you use to access the Web-based management interface. If you change the IP Address here, you may need to adjust your PC's network settings to access the network again." Below the text are two buttons: "Save Settings" and "Don't Save Settings".
 - LAN SETTINGS:** A section with a dark header. It contains instructions: "Use this section to configure the internal network settings of your bridge. The IP Address that is configured here is the IP Address that you use to access the Web-based management interface. If you change the IP Address here, you may need to adjust your PC's network settings to access the network again." Below the text is a dropdown menu labeled "LAN Connection Type" with "Dynamic IP (DHCP)" selected.
 - DEVICE NAME (NETBIOS NAME):** A section with a dark header. It contains a text input field labeled "Device Name" with the value "dlinkap" entered.
- Right Sidebar:** A "Helpful Hints..." section with text: "If you have a DHCP server on your network, you can select DHCP to get the IP address from a DHCP server." Below this is a "More..." link.
- Footer:** A dark bar with the word "WIRELESS" in white text.

Advanced Advanced Wireless

Transmit Power: Set the transmit power of the antennas.

RTS Threshold: This value should remain at its default setting of 2346. If inconsistent data flow is a problem, only a minor modification should be made.

Fragmentation Threshold: The fragmentation threshold, which is specified in bytes, determines whether packets will be fragmented. Packets exceeding the 2346 byte setting will be fragmented before transmission. 2346 is the default setting.

Short GI: Check this box to reduce the guard interval time therefore increasing the data capacity. However, it is less reliable and may create higher data loss.

The screenshot shows the D-Link DAP-1522 web interface. The top navigation bar includes 'DAP-1522 //', 'SETUP', 'ADVANCED', 'MAINTENANCE', 'STATUS', and 'HELP'. The 'ADVANCED' tab is active, and the 'ADVANCED WIRELESS' sub-tab is selected. A warning message states: 'If you are not familiar with these Advanced Wireless settings, please read the help section before attempting to modify these settings.' Below this are 'Save Settings' and 'Don't Save Settings' buttons. The 'ADVANCED WIRELESS SETTINGS' section contains the following options:

- Transmit Power :** 100% (dropdown menu)
- RTS Threshold :** 2346 (range: 256~2346, default:2346)
- Fragmentation Threshold :** 2346 (range: 1500~2346, default:2346, even number only)
- Short GI :**

On the right side, there is a 'Helpful Hints...' section with the text: 'It is recommended that you leave these parameters at their default values. Adjusting them could limit the performance of your wireless network.' and a 'More...' link.

QoS

The Quality of Service (QoS) feature regulates the flow of data through the access point by assigning a priority to each packet. It enhances your experience of wireless network usage by prioritizing the traffic of different applications. Enabling this option allows the AP to prioritize traffic. There are two options available for the special application.

Enable QoS: Enable this option if you want QoS to prioritize your traffic.

QoS Type: There are two options available for your special application: (1) Priority by LAN Port, and (2) Priority by Protocol.

Priority by LAN Port: There are four priority levels for all LAN ports. The priority level values assigned are 1 for Background, 3 for Best Effort, 5 for Video, and 7 for Voice (Voice is the highest level and Background is the lowest level) at a normal priority.

D-Link

DAP-1522 // SETUP ADVANCED MAINTENANCE STATUS HELP

ADVANCED WIRELESS

QoS

SCHEDULE

QoS

QoS prioritizes the traffic of various wireless applications.

Save Settings Don't Save Settings

QoS

Enable QoS :

QoS Type : Priority by LAN Port

PORT QoS

LAN Port 1 Priority : Background

LAN Port 2 Priority : Best Effort

LAN Port 3 Priority : Video

LAN Port 4 Priority : Voice

Helpful Hints...

Enable this option if you want to allow QoS to prioritize wireless traffic.

There are two options for QoS Type selected, such as priority by Lan port and by protocol, which ensure the right priorities available for your special applications.

More...

Priority by Protocol: Users can set the priority and percentage of total bandwidth reserved for each of their four traffic categories. Please note that the combined percentage value of transmission limits does not have to be 100%. These percentages represent the maximum bandwidth designated for each traffic category.

Ethernet to Wireless: The value entered here indicates the Ethernet to wireless speed required before the Advanced QoS function is enabled. Advanced QoS will be enabled once the total bandwidth reaches or surpasses the set value. The suggested range is 800 ~ 96000kbits/sec.

Wireless to Ethernet: The value entered here indicates the wireless to Ethernet speed required before the Advanced QoS function is enabled. Advanced QoS will be enabled once the total bandwidth reaches or surpasses the set value. The suggested range is 800 ~ 96000kbits/sec.

ACK/DHCP/ICMP/DNS Priority: Represents the priority value and bandwidth limit applied to ACK, DHCP, ICMP, and DNS for packet delivering.

Web Traffic Priority: Traffic generated by typical Web services (packets sent through ports 80,443, 3128 and 8080).

Mail Traffic Priority: Traffic generated by e-mail sending and receiving (ports 25, 110, 465 and 995).

Ftp Traffic Priority: Traffic generated by FTP Uploading and Downloading (ports 20, 21).

Other Traffic Priority: Other traffic generated that does not regard the aforementioned packet delivery.

Note: Normally the wireless connection transmits application data packets based on the wireless to Ethernet speed and Ethernet to wireless speed. Users can treat the two speeds as system transmission bandwidth, where all applications will share the whole system bandwidth based on assigned priorities. ~~Note that the maximum amount of bandwidth that can be used is the same as the set value of both speeds.~~

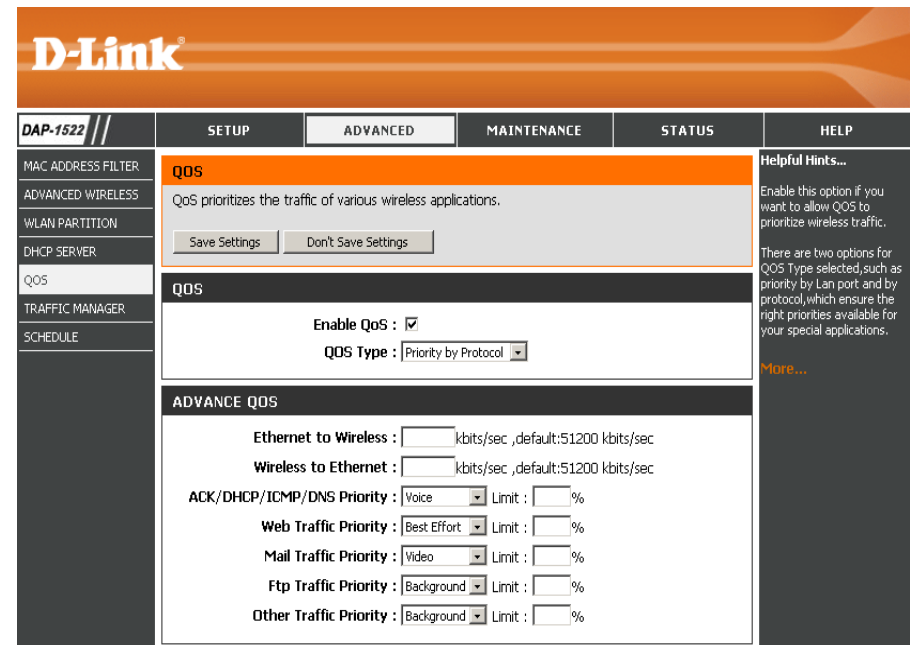

Schedule

Name: Enter a name for your new schedule.

Days: Select a day, a range of days, or All Week to include every day.

Time: Check **All Days** or enter a start and end time for your schedule.

Wireless: Select **On** or **Off** from the drop-down menu.

Add: Click **Add** to save your schedule. You must click **Save Settings** at the top for your schedules to go into effect.

Schedule Rules The list of schedules will be listed here. Click the **List:** **Edit** icon to make changes or click the **Delete** icon to remove the schedule.

D-Link

DAP-1522 // SETUP ADVANCED MAINTENANCE STATUS HELP

ADVANCED WIRELESS WIRELESS SCHEDULE SETTINGS Helpful Hints...
DAP-1522's radio can be scheduled by week or by individual days.

QOS Save Settings Don't Save Settings

SCHEDULE WIRELESS SCHEDULE SETTINGS
 Wireless Schedule : Disable

ADD SCHEDULE RULE

Name :

Day(s) : All Week Select Day(s)
 Sun Mon Tue Wed Thu Fri Sat

All Day(s)

Start Time : : (hour:minute, 24 hour time)

End Time : : (hour:minute, 24 hour time)

Wireless : Off

Add Clear

SCHEDULE RULE LIST

Name	Day(s)	Time Frame	Wireless	Edit	Delete

WIRELESS

Maintenance

Admin

This page will allow you to change the Administrator password. Admin has read/write access.

Password: Enter a new password for the Administrator Login Name. The administrator can make changes to the settings.

Verify Password: Enter the same password that you entered in the previous textbox in order to confirm its accuracy.

The screenshot shows the D-Link web interface for the DAP-1522 device. The top navigation bar includes 'D-Link', 'DAP-1522', and tabs for 'SETUP', 'ADVANCED', 'MAINTENANCE', 'STATUS', and 'HELP'. The 'MAINTENANCE' tab is active, and the 'ADMIN' sub-tab is selected in the left sidebar. The main content area is titled 'ADMINISTRATOR SETTINGS' and contains the following text: 'The 'admin' accounts can access the management interface. The admin has read/write access and can change passwords. By default there is no password configured. It is highly recommended that you create a password to keep your access point secure.' Below this text are two buttons: 'Save Settings' and 'Don't Save Settings'. A section titled 'ADMIN PASSWORD' contains the instruction: 'Please enter the same password into both boxes, for confirmation.' This section has two password input fields: 'Password : [mask]' and 'Verify Password : [mask]'. On the right side, there is a 'Helpful Hints...' section with the text: 'For security reasons, it is recommended that you change the password for the Admin. Be sure to write down the new passwords to avoid having to reset the access point in case they are forgotten.' and a 'More...' link.

Time

The Time Configuration option allows you to configure, update, and maintain the correct time on the internal system clock. From this section you can set the time zone that you are in. Daylight Saving can also be configured to automatically adjust the time when needed.

Time Zone: Select the Time Zone from the drop-down menu.

Daylight Saving: To select Daylight Saving time manually, tick the Enable Daylight Saving check box. Next use the drop-down menu to select a Daylight Saving Offset and then enter a start date and an end date for daylight saving time.

Enable NTP Server: NTP is short for Network Time Protocol. NTP synchronizes computer clock times in a network of computers. Check this box to use a NTP server. This will only connect to a server on the Internet, not a local server.

NTP Server Used: Enter the NTP server or select one from the drop-down menu.

Manual: To manually input the time, enter the values in these fields for the Year, Month, Day, Hour, Minute, and Second and then click **Save Settings**. You can also click the **Copy Your Computer's Time Settings** button at the bottom of the screen.

The screenshot shows the D-Link DAP-1522 web interface. The top navigation bar includes 'DAP-1522 //', 'SETUP', 'ADVANCED', 'MAINTENANCE', 'STATUS', and 'HELP'. The left sidebar lists 'ADMIN', 'TIME', 'SYSTEM', and 'FIRMWARE'. The main content area is titled 'TIME' and contains the following sections:

- TIME CONFIGURATION:**
 - Time: 01/01/2000 00:05:51
 - Time Zone: (GMT-08:00) Pacific Time (US & Canada); Tijuana
 - Enable Daylight Saving:
 - Daylight Saving Offset: +1:00
 - Daylight Saving Dates:

	Month	Week	Day of Week	Time
DST Start	Jan	1st	Sun	12 am
DST End	Jan	1st	Sun	12 am
- AUTOMATIC TIME CONFIGURATION:**
 - Enable NTP server:
 - NTP Server: [Text Field] << Select NTP Server
- SET THE DATE AND TIME MANUALLY:**
 - Date And Time:

Year	2009	Month	Jul	Day	17
Hour	2	Minute	57	Second	10
					PM
 - Copy Your Computer's Time Settings

Buttons for 'Save Settings' and 'Don't Save Settings' are located below the TIME CONFIGURATION section. A 'Helpful Hints...' sidebar on the right contains the text: 'Good timekeeping is important for accurate logs. More...'

System

Save To Local Hard Drive: Use this option to save the current access point configuration settings to a file on the hard disk of the computer you are using. First, click the **Save** button. You will then see a file dialog, where you can select a location and file name for the settings.

Load From Local Hard Drive: Use this option to load previously saved access point configuration settings. First, use the Browse control to find a previously save file of configuration settings. Then, click the **Load** button to transfer those settings to the access point.

Restore To Factory Default: This option will restore all configuration settings back to the settings that were in effect at the time the access point was shipped from the factory. Any settings that have not been saved will be lost, including any rules that you have created. If you want to save the current access point configuration settings, use the **Save** button above.

Reboot The Device: Click to reboot the bridge.

Clear Language Pack: Click to clear the language pack. This will put the web UI back to English.

D-Link

DAP-1522 // SETUP ADVANCED MAINTENANCE STATUS HELP

ADMIN
TIME
SYSTEM
FIRMWARE

SYSTEM SETTINGS

The System Settings section allows you to reboot the device, or restore the access point to the factory default settings. Restoring the unit to the factory default settings will erase all settings, including any rules that you have created.

The current system settings can be saved as a file onto the local hard drive. The saved file or any other saved setting file created by device can be uploaded into the unit.

SYSTEM SETTINGS

Save To Local Hard Drive :

Load From Local Hard Drive :

Restore To Factory Default :
Restore all settings to the factory defaults.

Reboot The Device :

Clear Language Pack :

Helpful Hints...

Once your access point is configured the way you want it, you can save the configuration settings to a configuration file.

You might need this file so that you can load your configuration later in the event that the access point's default settings are restored.

To save the configuration, click the "Save Configuration" button.

[More...](#)

Firmware

You can upgrade the firmware of the access point here. Make sure the firmware you want to use is on the local hard drive of the computer. Click on **Browse** to locate the firmware file to be used for the update. Please check the D-Link support site for firmware updates at <http://support.dlink.com>. You can download firmware upgrades to your hard drive from the D-Link support site.

Browse: After you have downloaded the new firmware, click **Browse** to locate the firmware update on your hard drive. Click **Upload** to complete the firmware upgrade.

Upload: Once you have a firmware update on your computer, use this option to browse for the file and then upload the information into the bridge.

Language Pack

You can change the language of the web UI by uploading available language packs.

Browse: After you have downloaded the new language pack, click **Browse** to locate the language pack file on your hard drive. Click **Upload** to complete the language pack upgrade.

The screenshot shows the D-Link web interface for a DAP-1522 access point. The interface is divided into several sections:

- Header:** D-Link logo and navigation tabs: DAP-1522 // SETUP, ADVANCED, MAINTENANCE, STATUS, HELP.
- Left Sidebar:** ADMIN, TIME, SYSTEM, FIRMWARE.
- Main Content Area:**
 - FIRMWARE:** Use the Firmware section to install the latest firmware code to improve functionality and performance. Includes buttons for "Save Settings" and "Don't Save Settings".
 - FIRMWARE INFORMATION:**
 - Current Firmware Version : 1.21
 - Current Firmware Date : 09:31:38 06/04/2009
 - FIRMWARE UPGRADE:**
 - Note: Some firmware upgrades reset the configuration options to the factory defaults. Before performing an upgrade, be sure to save the current configuration from the Maintenance -> Admin screen.
 - To upgrade the firmware, your PC must have a wired connection to the access point. Enter the name of the firmware upgrade file, and click on the Upload button.
 - Upload :
 - LANGUAGE PACKAGE INFORMATION:**
 - Note: Update language package will make changes language display on web page. Before performing an upgrade, be sure to do it!
 - To upgrade the language package, your PC must have a wired connection to the access point. Enter the name of the language package upgrade file, and click on the Upload button.
 - Upload :
- Right Sidebar:** Helpful Hints... (Firmware updates are released periodically to improve the functionality of your access point and to add features. If you run into a problem with a specific feature of the access point, check our support site by clicking the "Click here to check for an upgrade on our support site" link and see if updated firmware is available for your access point.) More...
- Footer:** WIRELESS

If you load a language pack and would like to go back to English, click **Maintenance > System** and click on **Clear** next to **Clear Language Pack**.

DAP-1522 //	SETUP	ERWEITERT	WARTUNG	STATUS	HILFE
ADMIN	SYSTEMEINSTELLUNGEN				<p>Nützliche Hinweise...</p> <p>Sobald Ihr Access Point wie gewünscht konfiguriert ist, können Sie die Konfigurationseinstellungen in einer Konfigurationsdatei speichern.</p> <p>Sie benötigen diese Datei möglicherweise, damit Sie Ihre Konfiguration später laden können, falls die Standardeinstellungen des Access Point wiederhergestellt wurden.</p> <p>Klicken Sie auf die Schaltfläche "Konfiguration speichern", um die Konfiguration zu speichern.</p> <p>Mehr...</p>
ZEIT	<p>Im Abschnitt "Systemeinstellungen" können Sie das Gerät neu starten oder den Access Point auf die Werkseinstellungen zurücksetzen. Wenn das Gerät auf die Werkseinstellungen zurückgesetzt wird, werden alle Einstellungen, einschließlich aller von Ihnen erstellten Regeln, gelöscht.</p> <p>Die aktuellen Systemeinstellungen können als Datei auf der lokalen Festplatte gespeichert werden. Die gespeicherte Datei oder eine andere vom Gerät erstellte, gespeicherte Einstellungsdatei kann in das Gerät geladen werden.</p>				
SYSTEM	<p>SYSTEMEINSTELLUNGEN</p> <p>Auf der lokalen Festplatte speichern : <input type="button" value="Konfiguration speichern"/></p> <p>Von der lokalen Festplatte laden : <input type="text"/> <input type="button" value="Browse..."/> <input type="button" value="Konfiguration von Datei wiederherstellen"/></p> <p>Auf Werkseinstellungen zurücksetzen : <input type="button" value="Werkseinstellungen wiederherstellen"/> Alle Einstellungen auf die Werkseinstellungen zurücksetzen.</p> <p>Starten Sie das Gerät neu : <input type="button" value="Starten Sie das Gerät neu"/></p>				
FIRMWARE	<p>Sprachpaket löschen: <input type="button" value="Entfernen"/></p>				

DAP-1522 //	CONFIGURACIÓN	AVANZADO	MANTENIMIENTO	ESTADO	AYUDA
ADMINISTRADOR	PARÁMETROS DEL SISTEMA				<p>Sugerencias útiles...</p> <p>Una vez que el punto de acceso está configurado como lo desea, puede guardar los parámetros de configuración en un archivo de configuración.</p> <p>Puede que necesite este archivo para poder cargar la configuración más adelante en el caso de que se restablezcan los parámetros predeterminados del punto de acceso.</p> <p>Para guardar la configuración, haga clic en el botón "Guardar configuración".</p> <p>Más información...</p>
HORA	<p>La sección Parámetros del sistema le permite reiniciar el dispositivo o restaurar el punto de acceso a los parámetros predeterminados de fábrica. Al restaurar en la unidad los parámetros predeterminados de fábrica se borrarán todos los parámetros, incluidas las reglas que haya creado.</p> <p>Se pueden guardar los parámetros del sistema actual como un archivo en la unidad de disco duro local. Puede cargarse en la unidad el archivo guardado o cualquier otro archivo de parámetros guardado creado por el dispositivo.</p>				
SISTEMA	<p>PARÁMETROS DEL SISTEMA</p> <p>Guardar en la unidad de disco duro local : <input type="button" value="Guardar configuración"/></p> <p>Cargar desde la unidad de disco duro local : <input type="text"/> <input type="button" value="Browse..."/> <input type="button" value="Restablecer la configuración del archivo"/></p> <p>Restablecer en los valores predeterminados de fábrica : <input type="button" value="Restablecer valores predeterminados de fábrica"/> Restablecer todos los parámetros en los valores predeterminados de fábrica.</p> <p>Reinicie el dispositivo : <input type="button" value="Reiniciar el dispositivo"/></p>				
FIRMWARE	<p>Borrar paquete de idioma: <input type="button" value="Borrar"/></p>				

DAP-1522 //	CONFIGURATION	AVANÇÉ	MAINTENANCE	ÉTAT	AIDE
ADMIN	PARAMÈTRES SYSTÈME				<p>Conseils utiles...</p> <p>Une fois le point d'accès configuré comme vous le souhaitez, vous pouvez enregistrer les paramètres de configuration dans un fichier de configuration.</p> <p>Vous aurez peut-être besoin de ce fichier pour charger votre configuration ultérieurement, en cas de restauration des paramètres par défaut de votre point d'accès.</p> <p>Pour enregistrer la configuration, cliquez sur le bouton "Enregistrer la configuration".</p> <p>Plus...</p>
HEURE	<p>La section Configuration du système vous permet de réinitialiser le périphérique ou de restaurer les paramètres d'usine point d'accès. Restaurer les valeurs d'usine de tous les paramètres efface tous vos paramètres, y compris toutes les règles que vous avez créées.</p> <p>La configuration actuelle du système peut être enregistrée sous forme de fichier sur le disque dur local. Le fichier enregistré ou tout autre fichier de configuration enregistré et créé par le périphérique peut être chargé sur la machine.</p>				
SYSTÈME	<p>PARAMÈTRES SYSTÈME</p> <p>Enregistrer sur le disque dur local : <input type="button" value="Enregistrer la configuration"/></p> <p>Charger depuis le disque dur local : <input type="text"/> <input type="button" value="Browse..."/> <input type="button" value="Restaurer la configuration à partir d'un fichier"/></p> <p>Restaurer les paramètres par défaut : <input type="button" value="Restaurer les valeurs d'usine"/> Restaurer tous les paramètres sur les valeurs définies à l'usine.</p> <p>Réinitialiser le périphérique : <input type="button" value="Réinitialiser le périphérique"/></p>				
MICROPROGRAMME	<p>Effacer le pack linguistique : <input type="button" value="Effacer"/></p>				

DAP-1522 //	CONFIGURAZIONE	AVANZATE	MANUTENZIONE	STATO	GUIDA
ADMIN	IMPOSTAZIONI SISTEMA				<p>Suggerimenti utili...</p> <p>Dopo aver configurato il punto di accesso nel modo desiderato, è possibile salvare le impostazioni in un apposito file di configurazione.</p> <p>Tale file potrebbe essere necessario per caricare la configurazione in un secondo momento qualora venissero ripristinate le impostazioni predefinite del punto di accesso.</p> <p>Per salvare la configurazione, fare clic sul pulsante "Salva configurazione".</p> <p>Altro...</p>
ORA	<p>La sezione Impostazioni sistema consente di riavviare il dispositivo o di ripristinare le impostazioni predefinite del punto di accesso. Il ripristino delle impostazioni predefinite comporta la cancellazione di tutte le impostazioni precedenti, incluse eventuali regole create dall'utente.</p> <p>È possibile salvare le impostazioni di sistema correnti in un file del disco fisso locale. Il file salvato o qualsiasi altro file di impostazioni salvato creato dal dispositivo può quindi essere caricato nell'unità.</p>				
SISTEMA	<p>IMPOSTAZIONI SISTEMA</p> <p>Salva su Disco fisso locale : <input type="button" value="Salva configurazione"/></p> <p>Carica da disco fisso locale : <input type="text"/> <input type="button" value="Browse..."/> <input type="button" value="Ripristina configurazione da file"/></p> <p>Ripristina impostazioni predefinite : <input type="button" value="Ripristina impostazioni predefinite"/> Ripristina tutte le impostazioni predefinite.</p> <p>Riavvio del dispositivo : <input type="button" value="Riavvio del dispositivo"/></p>				
FIRMWARE	<p>Cancela Language Pack: <input type="button" value="Cancella"/></p>				

Status

Device Info

This page displays the current information for the DAP-1522. It will display the LAN and wireless LAN information.

General: Displays the access point's time and firmware version.

LAN: Displays the MAC address and the private (local) IP settings for the access point.

Wireless LAN: Displays the wireless MAC address and your wireless settings such as SSID and Channel.

D-Link	
DAP-1522	SETUP ADVANCED MAINTENANCE STATUS HELP
DEVICE INFO	DEVICE INFORMATION
LOGS	All of your network connection details are displayed on this page. The firmware version is also displayed here.
	GENERAL
	Firmware Version : 1.21 , Thu 04 Jun 2009
	LAN
	Connection Type : Static IP MAC Address : 00:22:b0:73:50:5f IP Address : 192.168.0.50 Subnet Mask : 255.255.255.0 Default Gateway :
	WIRELESS LAN
	Wireless Radio : Enabled Status : connected MAC Address : 00:22:b0:73:50:5f Network Name(SSID) : dlink Channel : 11 Security Type : Open / Disabled Wi-Fi Protected Setup : Enabled / Not Configured
	WIRELESS

Helpful Hints...
All of your LAN and WLAN connection details are displayed here.
[More...](#)

Logs

The access point automatically logs (records) events of possible interest in its internal memory. If there isn't enough internal memory for all events, logs of older events are deleted, but logs of the latest events are retained. The Logs option allows you to view the access point logs. You can define what types of events you want to view and the level of the events to view. This access point also has external Syslog Server support so you can send the log files to a computer on your network that is running a Syslog utility.

What to View: There are three types of logs that can be viewed: **System Activity**, **Wireless Activity**, and **Notice**. Click on the corresponding check box for the type(s) that you want displayed in the log.

Enable Remote Log: Select this check box and enter a Log Server name or IP address to enable the remote log feature.

Apply Log Settings Now: Click this button to immediately filter the log results so that only the selected options appear in the Log Details section of this screen.

Refresh: Updates the log details on the screen so it displays any recent activity.

Clear: This option clears all of the log contents.

Save Log: This option will save the access point to a log file on your computer.

D-Link

DAP-1522 //

SETUP ADVANCED MAINTENANCE STATUS HELP

LOGS

View the logs. You can define the event levels to view.

LOG OPTIONS

What to View : System Activity Wireless Activity Notice

Enable Remote Log : **Log Server / IP Address :**

LOG DETAILS

Page 1 of 2

Time	Priority	Message
Uptime 0 day 09:55:44	[Wireless]	Initiate Wireless success
Uptime 0 day 09:55:39	[Wireless]	Stop Wireless success
Uptime 0 day 09:55:39	[Wireless]	Initiate Wireless success
Uptime 0 day 09:55:38	[Wireless]	Stop Wireless success
Uptime 0 day 09:32:23	[SYSACT]	Web login success from 192.168.0.5
Uptime 0 day 09:32:14	[SYSACT]	Device is operating in Bridge mode!
Uptime 0 day 09:32:07	[Wireless]	Initiate Wireless success
Uptime 0 day 09:32:05	[Wireless]	Stop Wireless success
Uptime 0 day 09:30:05	[SYSACT]	Web login success from 192.168.0.5
Uptime 0 day 09:27:59	[SYSACT]	Web logout from 192.168.0.5

Helpful Hints..
Check the log frequently to detect unauthorized network usage.
[More...](#)

Help

D-Link

DAP-1522 //

SETUP **ADVANCED** **MAINTENANCE** **STATUS** **HELP**

MENU

SETUP

ADVANCED

MAINTENANCE

STATUS

SUPPORT MENU

Setup Help

- [Wizard](#)
- [Wireless](#)
- [Network Settings](#)

Advanced Help

- [Advanced Wireless](#)
- [QoS](#)
- [Schedule](#)

Maintenance Help

- [Admin](#)
- [Time](#)
- [System](#)
- [Firmware](#)

Status Help

- [Device Info](#)
- [Logs](#)

Helpful Hints...

Wireless Security

This section will show you the different levels of security you can use to protect your data from intruders. The DAP-1522 offers the following types of security:

- WPA2 (Wi-Fi Protected Access 2)
- WPA (Wi-Fi Protected Access)
- WEP (Wired Equivalent Privacy)
- WPA2-PSK (Pre-Shared Key)
- WPA-PSK (Pre-Shared Key)

What is WEP?

WEP stands for *Wired Equivalent Privacy*. It is based on the IEEE 802.11 standard and uses the RC4 encryption algorithm. WEP provides security by encrypting data over your wireless network so that it is protected as it is transmitted from one wireless device to another.

To gain access to a WEP network, you must know the key. The key is a string of characters that you create. When using WEP, you must determine the level of encryption. The type of encryption determines the key length. 128-bit encryption requires a longer key than 64-bit encryption. Keys are defined by entering in a string in HEX (hexadecimal - using characters 0-9, A-F) or ASCII (American Standard Code for Information Interchange – alphanumeric characters) format. ASCII format is provided so you can enter a string that is easier to remember. The ASCII string is converted to HEX for use over the network. Four keys can be defined so that you can change keys easily.

What is WPA?

WPA, or Wi-Fi Protected Access, is a Wi-Fi standard that was designed to improve the security features of WEP (Wired Equivalent Privacy).

The 2 major improvements over WEP:

- Improved data encryption through the Temporal Key Integrity Protocol (TKIP). TKIP scrambles the keys using a hashing algorithm and, by adding an integrity-checking feature, ensures that the keys haven't been tampered with. WPA2 is based on 802.11i and uses Advanced Encryption Standard (AES) instead of TKIP.
- User authentication, which is generally missing in WEP, through the extensible authentication protocol (EAP). WEP regulates access to a wireless network based on a computer's hardware-specific MAC address, which is relatively simple to be sniffed out and stolen. EAP is built on a more secure public-key encryption system to ensure that only authorized network users can access the network.

WPA-PSK/WPA2-PSK uses a passphrase or key to authenticate your wireless connection. The key is an alpha-numeric password between 8 and 63 characters long. The password can include symbols (!?*&_) and spaces. This key must be the exact same key entered on your wireless bridge or access point.

WPA/WPA2 incorporates user authentication through the Extensible Authentication Protocol (EAP). EAP is built on a more secure public key encryption system to ensure that only authorized network users can access the network.

Configure WEP in AP Mode

It is recommended to enable encryption on your wireless access point before your wireless network adapters. Please establish wireless connectivity before enabling encryption. Your wireless signal may degrade when enabling encryption due to the added overhead.

1. Log into the web-based configuration by opening a web browser and entering the IP address of the access point (192.168.0.50). Click on **Setup** and then click **Wireless Settings** on the left side.
2. Next to Security Mode in the Wireless Security Mode section, select **WEP**.
3. Next to WEP Key Length in the WEP section, select both the type of input (hexidecimal or ASCII) and the level of encryption (64-bit or 128-bit). Hex - (recommended) Letters A-F and numbers 0-9 are valid.
4. Next to Default WEP Key and the first selection on the drop-down menu, WEP Key 1. Enter a WEP key that you create in the WEP Key value and Verify WEP Key value fields. Make sure you enter this key exactly on all your wireless devices. You may enter up to 4 different keys using the Default WEP Key drop-down menu.
5. Next to *Authentication*, select **Open** or **Shared Key**.
6. Click **Save Settings** at the top of the window to save your settings. If you are configuring the access point with a wireless adapter, you will lose connectivity until you enable WEP on your adapter and enter the same WEP key as you did on the access point.

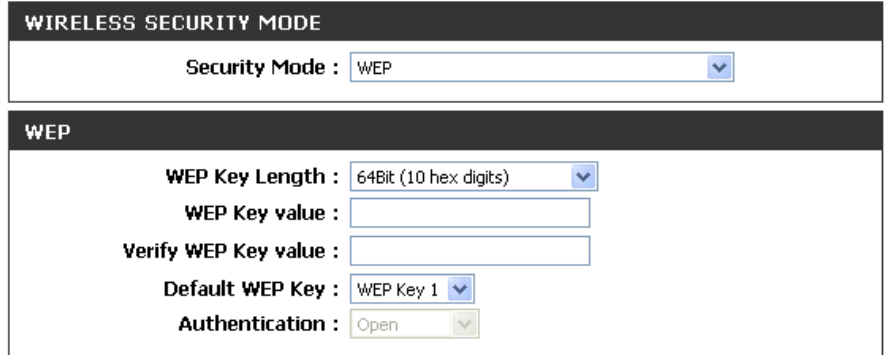

The screenshot displays the 'WIRELESS SECURITY MODE' configuration page. The 'Security Mode' is set to 'WEP'. Below this, the 'WEP' section is expanded, showing the following settings: 'WEP Key Length' is set to '64Bit (10 hex digits)'; 'WEP Key value' and 'Verify WEP Key value' are empty text input fields; 'Default WEP Key' is set to 'WEP Key 1'; and 'Authentication' is set to 'Open'.

Configure WPA-Personal (AP Mode)

It is recommended to enable encryption on your wireless access point before your wireless network adapters. Please establish wireless connectivity before enabling encryption. Your wireless signal may degrade when enabling encryption due to the added overhead.

1. Log into the web-based configuration by opening a web browser and entering the IP address of the access point (192.168.0.50). Click on Setup and then click Wireless Settings on the left side.
2. Next to *Security Mode in the Wireless Security Mode section*, select **WPA-Personal**.
3. Next to *WPA Mode in the WPA section*, select **Auto (WPA or WPA2)**, **WPA2 Only**, or **WPA Only**. Use **Auto** if you have wireless clients using both WPA and WPA2.
4. Next to Cipher Type, select TKIP, AES, or TKIP and AES.
5. Next to *Group Key Update Interval*, enter the amount of time before the group key used for broadcast and multicast data is changed.
6. Next to the *Pre-Shared Key* section, enter a key in the Passphrase field. The key is entered as a passphrase in ASCII format at both ends of the wireless connection. The passphrase must be between 8-63 characters.
7. Click **Save Settings** at the top of the window to save your settings. If you are configuring the access point with a wireless adapter, you will lose connectivity until you enable WPA-PSK on your adapter and enter the same passphrase as you did on the access point.

The screenshot displays the configuration interface for wireless security. It is divided into three main sections: WIRELESS SECURITY MODE, WPA, and PRE-SHARED KEY. In the WIRELESS SECURITY MODE section, the Security Mode is set to WPA-Personal. The WPA section shows WPA Mode set to Auto (WPA or WPA2), Cipher Type set to TKIP, and a Group Key Update Interval of 1800 seconds. The PRE-SHARED KEY section has a Passphrase field that is currently empty.

WIRELESS SECURITY MODE	
Security Mode :	WPA-Personal

WPA	
WPA Mode :	Auto (WPA or WPA2)
Cipher Type :	TKIP
Group Key Update Interval :	1800 (seconds)

PRE-SHARED KEY	
Passphrase :	

Configure WPA-Enterprise (AP Mode)

It is recommended to enable encryption on your wireless access point before your wireless network adapters. Please establish wireless connectivity before enabling encryption. Your wireless signal may degrade when enabling encryption due to the added overhead.

1. Log into the web-based configuration by opening a web browser and entering the IP address of the access point (192.168.0.50). Click on **Setup** and then click **Wireless Settings** on the left side.
2. Next to *Security Mode in the Wireless Security Mode section*, select **WPA-Enterprise**.
3. Next to *WPA Mode in the WPA section*, select **Auto (WPA or WPA2), WPA2 Only, or WPA Only**. Use Auto if you have wireless clients using both WPA and WPA2.
4. Next to Cipher Type, select **TKIP, AES, or TKIP and AES**.
5. Next to *Group Key Update Interval*, enter the amount of time before the group key used for broadcast and multicast data is changed.
6. Next to *RADIUS Server IP Address* in the EAP (802.1X) section, enter the IP Address of your RADIUS server.
7. Next to RADIUS Server Port, enter the port you are using with your RADIUS server. 1812 is the default port.
8. Next to *RADIUS Server Shared Secret*, enter the security key.
9. Click **Save Settings** at the top of the window to save your settings.

The screenshot displays a web-based configuration interface for wireless security. It is divided into three main sections: WIRELESS SECURITY MODE, WPA, and EAP (802.1X). In the WIRELESS SECURITY MODE section, the Security Mode is set to WPA-Enterprise. The WPA section shows WPA Mode set to Auto (WPA or WPA2), Cipher Type set to TKIP, and Group Key Update Interval set to 1800 seconds. The EAP (802.1X) section contains fields for RADIUS Server IP Address, RADIUS Server Port (set to 1812), and RADIUS Server Shared Secret.

WIRELESS SECURITY MODE	
Security Mode :	WPA-Enterprise

WPA	
WPA Mode :	Auto (WPA or WPA2)
Cipher Type :	TKIP
Group Key Update Interval :	1800 (seconds)

EAP (802.1X)	
RADIUS Server IP Address :	
RADIUS Server Port :	1812
RADIUS Server Shared Secret :	

Configure WEP (Bridge Mode)

It is recommended to enable encryption on your wireless access point before your wireless network adapters. Please establish wireless connectivity before enabling encryption. Your wireless signal may degrade when enabling encryption due to the added overhead.

1. Log into the web-based configuration by opening a web browser and entering the IP address of the bridge (192.168.0.50). Click on **Setup** and then click **Wireless Settings**.

2. For **Security Mode** in the *Wireless Security Mode* section, select WEP.

3. Next to WEP Key Length in the WEP section, select both the type of input (hexidecimal or ASCII) and the level of encryption (64-bit or 128-bit). Hex - (recommended) Letters A-F and numbers 0-9 are valid.

The screenshot shows the 'WIRELESS SECURITY MODE' configuration page. The 'Security Mode' is set to 'WEP'. Below this, the 'WEP' section contains the following settings: 'WEP Key Length' is set to '64Bit (10 hex digits)'; 'WEP Key value' and 'Verify WEP Key value' are empty text input fields; 'Default WEP Key' is set to 'WEP Key 1'; and 'Authentication' is set to 'Open'.

4. For the Default WEP Key and the first selection on the drop-down menu, WEP Key 1. Enter a WEP key that you create in the WEP Key value and Verify WEP Key value fields. Make sure you enter this key exactly on all your wireless devices. You may enter up to 4 different keys using the Default WEP Key drop-down menu.

5. For *Authentication*, select **Open** or **Shared Key**.

6. Click **Save Settings** to save your settings. If you are configuring the access point with a wireless adapter, you will lose connectivity until you enable WEP on your adapter and enter the same WEP key as you did on the access point.

Configure WPA-Personal (Bridge Mode)

It is recommended to enable encryption on your wireless access point before your wireless network adapters. Please establish wireless connectivity before enabling encryption. Your wireless signal may degrade when enabling encryption due to the added overhead.

1. Log into the web-based configuration by opening a web browser and entering the IP address of the bridge (192.168.0.50). Click on **Setup** and then click **Wireless Settings** on the left side.
2. Next to *Security Mode in the Wireless Security Mode section*, select **WPA-Personal**.
3. Next to *WPA Mode in the WPA section*, select **Auto (WPA or WPA2)**, **WPA2 Only**, or **WPA Only**. Use **Auto** if you have wireless clients using both WPA and WPA2.
4. Next to Cipher Type, select **TKIP**, **AES**, or **TKIP and AES**.
5. Next to *Group Key Update Interval*, enter the amount of time before the group key used for broadcast and multicast data is changed.
6. Next to the *Pre-Shared Key section*, enter a key in the Passphrase field. The key is entered as a passphrase in ASCII format at both ends of the wireless connection. The passphrase must be between 8-63 characters.
7. Click **Save Settings** at the top of the window to save your settings. If you are configuring the access point with a wireless adapter, you will lose connectivity until you enable WPA-PSK on your adapter and enter the same passphrase as you did on the access point.

The screenshot displays the configuration interface for wireless security. It is divided into three main sections:

- WIRELESS SECURITY MODE:** Contains a dropdown menu for "Security Mode" which is currently set to "WPA-Personal".
- WPA:** Contains three fields: "WPA Mode" (dropdown menu set to "Auto (WPA or WPA2)"), "Cipher Type" (dropdown menu set to "TKIP"), and "Group Key Update Interval" (text input field followed by "(seconds)").
- PRE-SHARED KEY:** Contains a "Passphrase" text input field.

Connect to a Wireless Network

Using Windows® XP

Windows® XP users may use the built-in wireless utility (Zero Configuration Utility). The following instructions are for Service Pack 2 users. If you are using another company's utility or Windows® 2000, please refer to the user manual of your wireless adapter for help with connecting to a wireless network. Most utilities will have a "site survey" option similar to the Windows® XP utility as seen below.

If you receive the **Wireless Networks Detected** bubble, click on the center of the bubble to access the utility.

or

Right-click on the wireless computer icon in your system tray (lower-right corner next to the time). Select **View Available Wireless Networks**.

The utility will display any available wireless networks in your area. Click on a network (displayed using the SSID) and click the **Connect** button.

If you get a good signal, but cannot access the Internet, check you TCP/IP settings for your wireless adapter. Refer to the **Networking Basics** section in this manual for more information.

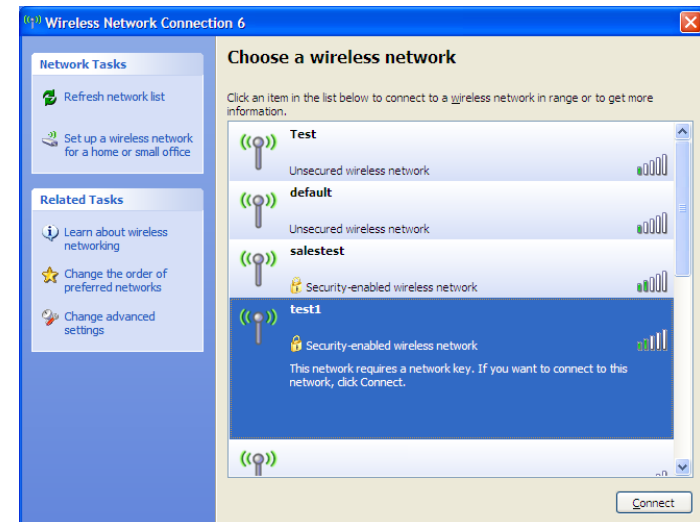
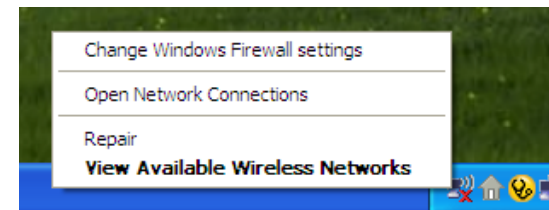
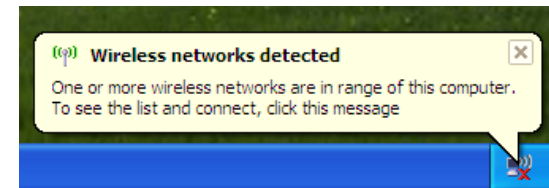

Configure WEP

It is recommended to enable WEP on your wireless bridge or access point before configuring your wireless adapter. If you are joining an existing network, you will need to know the WEP key being used.

1. Open the Windows® XP Wireless Utility by right-clicking on the wireless computer icon in your system tray (lower-right corner of screen). Select **View Available Wireless Networks**.

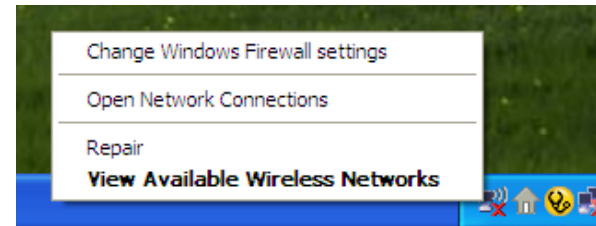

2. Highlight the wireless network (SSID) you would like to connect to and click **Connect**.

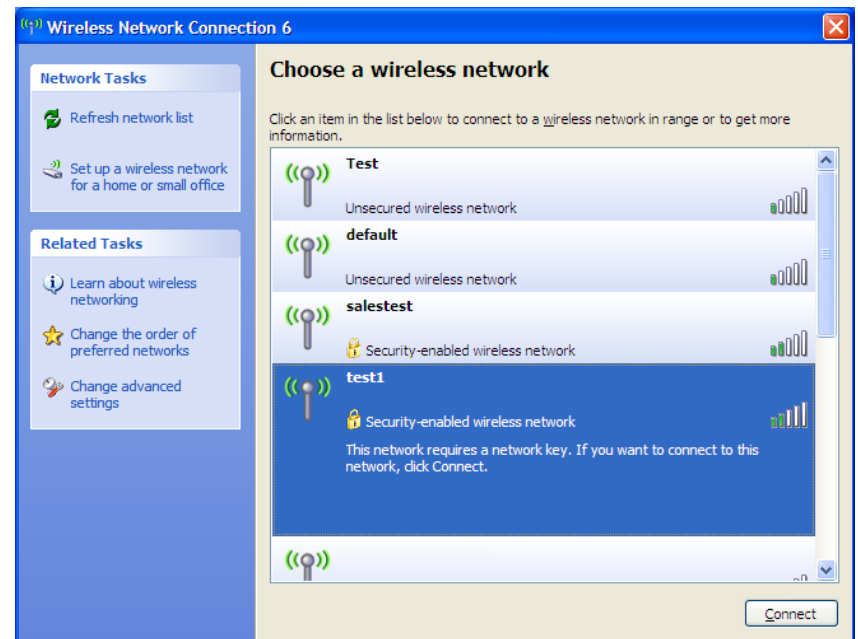

3. The **Wireless Network Connection** box will appear. Enter the same WEP key that is on your access point and click **Connect**.

It may take 20-30 seconds to connect to the wireless network. If the connection fails, please verify that the WEP settings are correct. The WEP key must be exactly the same as on the wireless access point.

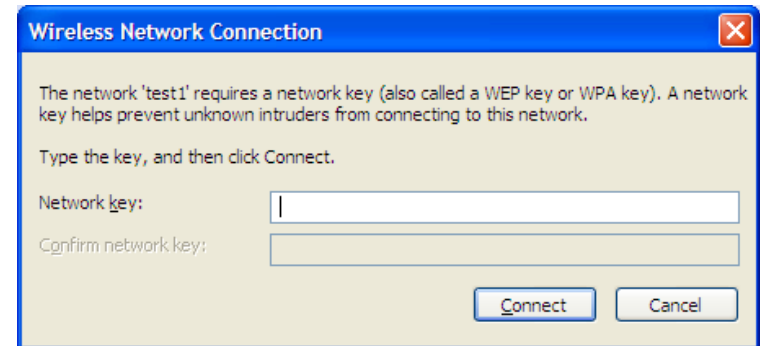

Configure WPA-PSK

It is recommended to enable WEP on your wireless bridge or access point before configuring your wireless adapter. If you are joining an existing network, you will need to know the WEP key being used.

1. Open the Windows® XP Wireless Utility by right-clicking on the wireless computer icon in your system tray (lower-right corner of screen). Select **View Available Wireless Networks**.

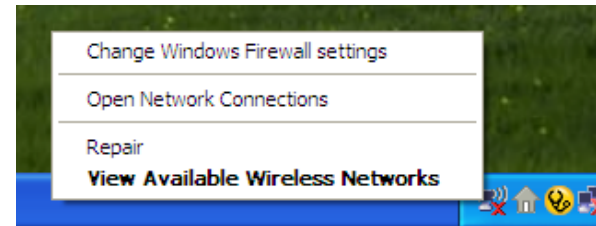

2. Highlight the wireless network (SSID) you would like to connect to and click **Connect**.

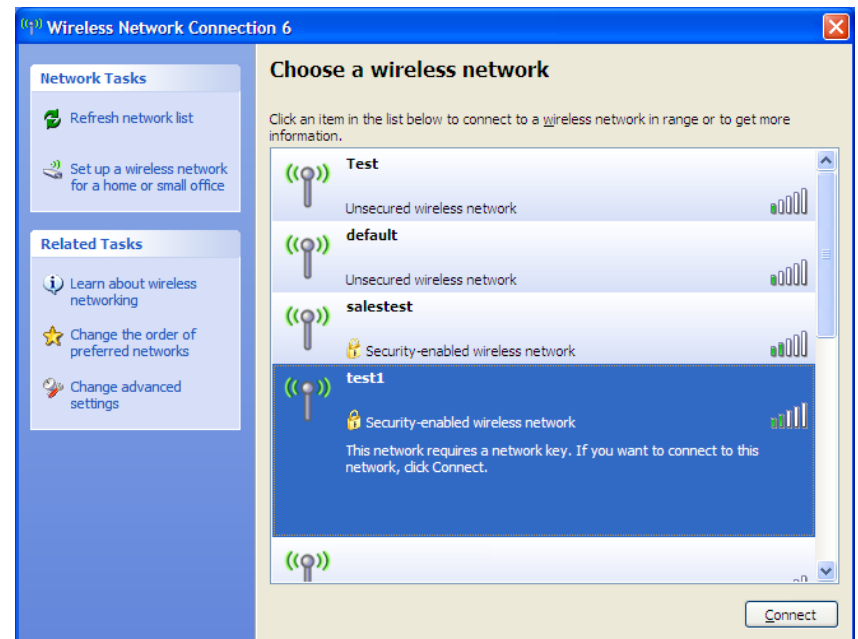

3. The **Wireless Network Connection** box will appear. Enter the WPA-PSK passphrase and click **Connect**.

It may take 20-30 seconds to connect to the wireless network. If the connection fails, please verify that the WPA-PSK settings are correct. The WPA-PSK passphrase must be exactly the same as on the wireless access point.

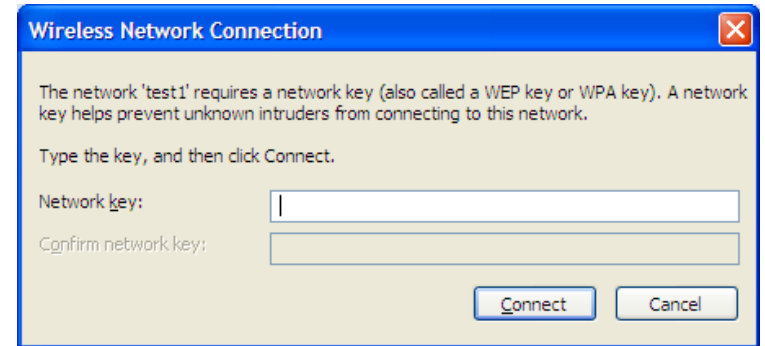

Connect to a Wireless Network Using Windows Vista®

Windows Vista® users may use the convenient, built-in wireless utility. Follow these instructions:

From the Start menu, go to Control Panel, and then click on **Network and Sharing Center**.

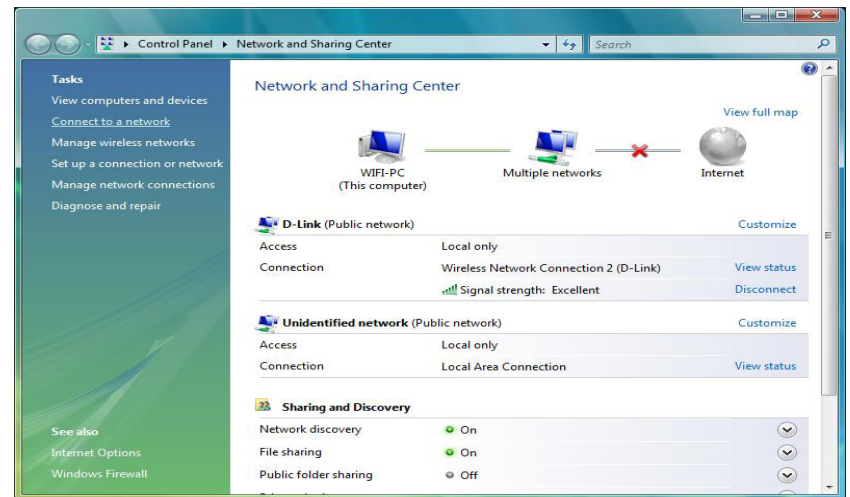

The utility will display any available wireless networks in your area. Click on a network (displayed using the SSID) under **Select a network to connect to** and then click the **Connect** button.

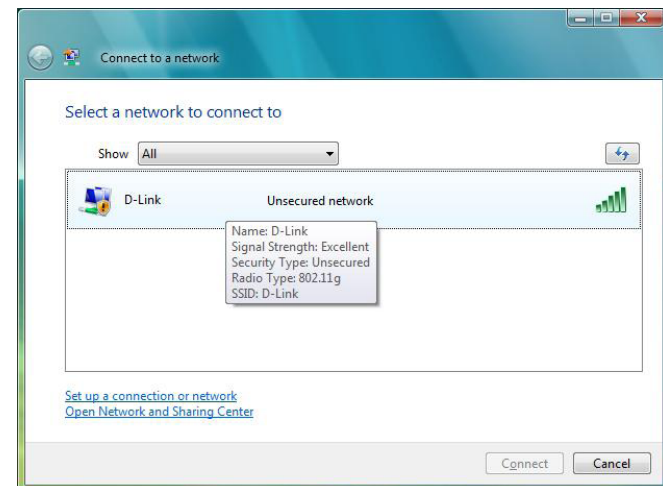

Click **Connect Anyway** to continue.

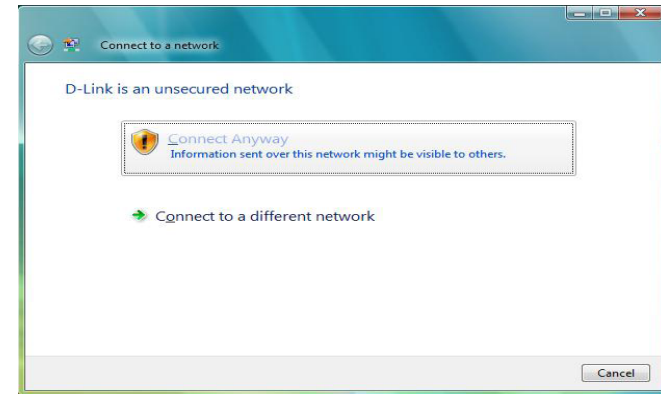

The utility will display the following window to indicate a connection is being made.

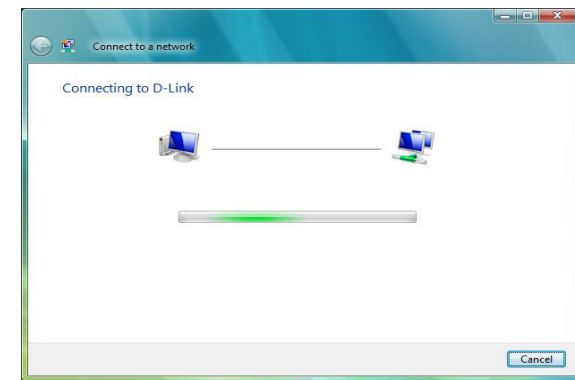

The final window indicates the establishment of a successful connection.

The next two pages display the windows used to connect to either a WEP or a WPA-PSK wireless network.

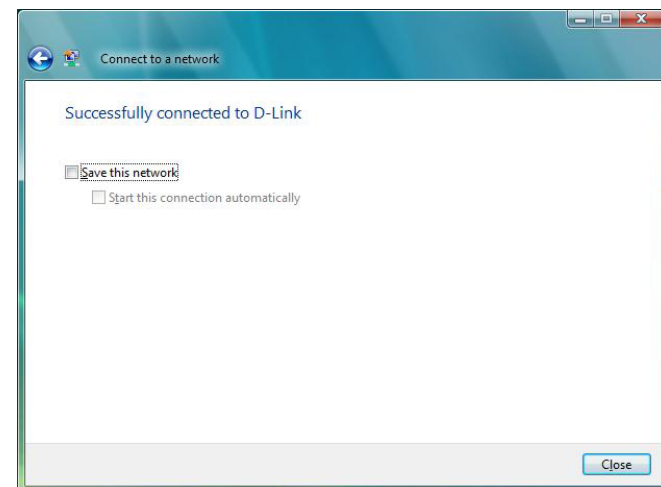

Configure WEP

It is recommended to enable WEP on your wireless bridge or access point before configuring your wireless adapter. If you are joining an existing network, you will need to know the WEP key being used.

Click on a network (displayed using the SSID) using WEP under Select a network to connect to and then click the **Connect** button.

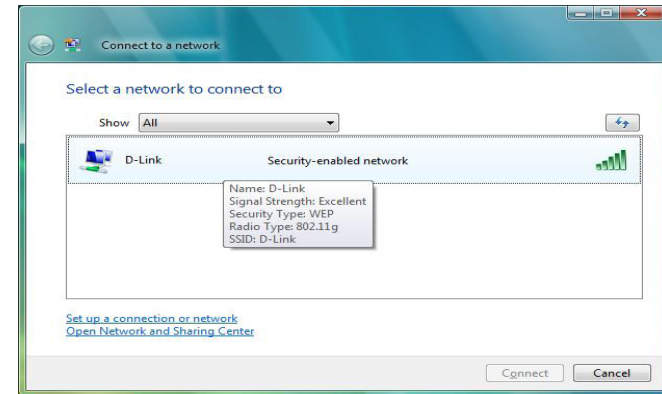

Enter the appropriate security key or passphrase in the field provided and then click the **Connect** button.



Configure WPA-PSK

It is recommended to enable WEP on your wireless bridge or access point before configuring your wireless adapter. If you are joining an existing network, you will need to know the WEP key being used.

Click on a network (displayed using the SSID) using WPA-PSK under Select a network to connect to and then click the **Connect** button.

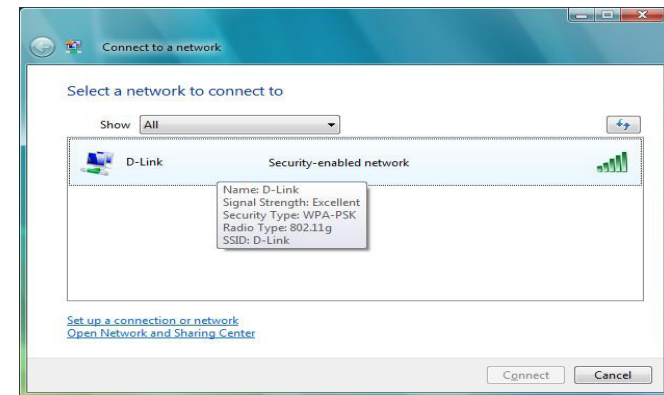

Enter the appropriate security key or passphrase in the field provided and then click the **Connect** button.

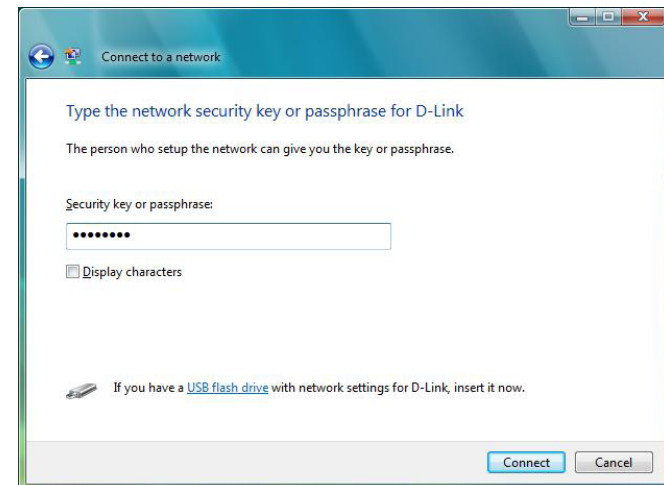

Troubleshooting

This chapter provides solutions to problems that can occur during the installation and operation of the DAP-1522. Read the following descriptions if you are having problems. (The examples below are illustrated in Windows® XP. If you have a different operating system, the screenshots on your computer will look similar to the following examples.)

1. Why can't I access the web-based configuration utility?

When entering the IP address of the D-Link access point (192.168.0.50 for example), you are not connecting to a website on the Internet or have to be connected to the Internet. The device has the utility built-in to a ROM chip in the device itself. Your computer must be on the same IP subnet to connect to the web-based utility.

- Make sure you have an updated Java-enabled web browser. We recommend the following:
 - Internet Explorer 6.0 or higher
 - Firefox 3.0 or higher
 - Safari 3.0 or higher
- Verify physical connectivity by checking for solid link lights on the device. If you do not get a solid link light, try using a different cable or connect to a different port on the device if possible. If the computer is turned off, the link light may not be on.
- Disable any internet security software running on the computer. Software firewalls such as Zone Alarm, Black Ice, Sygate, Norton Personal Firewall, and Windows® XP firewall may block access to the configuration pages. Check the help files included with your firewall software for more information on disabling or configuring it.

- Configure your Internet settings:
 - Go to **Start > Settings > Control Panel**. Double-click the **Internet Options** Icon. From the Security tab, click the button to restore the settings to their defaults.
 - Click the Connection tab and set the dial-up option to Never Dial a Connection. Click the LAN Settings button. Make sure nothing is checked. Click OK.
 - Go to the Advanced tab and click the button to restore these settings to their defaults. Click OK three times.
 - Close your web browser (if open) and open it.
- Access the web management. Open your web browser and enter the IP address of your D-Link access point in the address bar. This should open the login page for your the web management.
- If you still cannot access the configuration, unplug the power to the access point for 10 seconds and plug back in. Wait about 30 seconds and try accessing the configuration. If you have multiple computers, try connecting using a different computer.

2. What can I do if I forgot my password?

If you forgot your password, you must reset your access point. Unfortunately this process will change all your settings back to the factory defaults.

To reset the access point, locate the reset button (hole) on the rear panel of the unit. With the access point powered on, use a paperclip to hold the button down for 10 seconds. Release the button and the access point will go through its reboot process. Wait about 30 seconds to access the access point. The default IP address is 192.168.0.50. When logging in, the username is admin and leave the password box empty.

3. Why can't I connect to certain sites or send and receive emails when connecting through my access point?

If you are having a problem sending or receiving email, or connecting to secure sites such as eBay, banking sites, and Hotmail, we suggest lowering the MTU in increments of ten (Ex. 1492, 1482, 1472, etc).

Note: AOL DSL+ users must use MTU of 1400.

To find the proper MTU Size, you'll have to do a special ping of the destination you're trying to go to. A destination could be another computer, or a URL.

- Click on Start and then click Run.
- Windows® 95, 98, and Me users type in command (Windows® NT, 2000, and XP users type in cmd) and press Enter (or click OK).
- Once the window opens, you'll need to do a special ping. Use the following syntax:

```
ping [url] [-f] [-l] [MTU value]
```

Example: ping yahoo.com -f -l 1472

```
C:\>ping yahoo.com -f -l 1482
Pinging yahoo.com [66.94.234.13] with 1482 bytes of data:
Packet needs to be fragmented but DF set.
Packet needs to be fragmented but DF set.
Packet needs to be fragmented but DF set.
Packet needs to be fragmented but DF set.
Ping statistics for 66.94.234.13:
    Packets: Sent = 4, Received = 0, Lost = 4 (100% loss),
    Approximate round trip times in milli-seconds:
        Minimum = 0ms, Maximum = 0ms, Average = 0ms
C:\>ping yahoo.com -f -l 1472
Pinging yahoo.com [66.94.234.13] with 1472 bytes of data:
Reply from 66.94.234.13: bytes=1472 time=93ms TTL=52
Reply from 66.94.234.13: bytes=1472 time=109ms TTL=52
Reply from 66.94.234.13: bytes=1472 time=125ms TTL=52
Reply from 66.94.234.13: bytes=1472 time=203ms TTL=52
Ping statistics for 66.94.234.13:
    Packets: Sent = 4, Received = 4, Lost = 0 (0% loss),
    Approximate round trip times in milli-seconds:
        Minimum = 93ms, Maximum = 203ms, Average = 132ms
C:\>
```

You should start at 1472 and work your way down by 10 each time. Once you get a reply, go up by 2 until you get a fragmented packet. Take that value and add 28 to the value to account for the various TCP/IP headers. For example, let's say that 1452 was the proper value, the actual MTU size would be 1480, which is the optimum for the network we're working with ($1452+28=1480$).

Once you find your MTU, you can now configure your access point with the proper MTU size.

To change the MTU rate on your access point follow the steps below:

- Open your browser, enter the IP address of your access point (192.168.0.50) and click **OK**.
- Enter your username (admin) and password (blank by default). Click **OK** to enter the web configuration page for the device.
- Click on **Setup** and then click **Manual Configure**.
- To change the MTU enter the number in the MTU field and click **Save Settings** to save your settings.
- Test your email. If changing the MTU does not resolve the problem, continue changing the MTU in increments of ten.

Wireless Basics

D-Link wireless products are based on industry standards to provide easy-to-use and compatible high-speed wireless connectivity within your home, business or public access wireless networks. Strictly adhering to the IEEE standard, the D-Link wireless family of products will allow you to securely access the data you want, when and where you want it. You will be able to enjoy the freedom that wireless networking delivers.

A wireless local area network (WLAN) is a cellular computer network that transmits and receives data with radio signals instead of wires. Wireless LANs are used increasingly in both home and office environments, and public areas such as airports, coffee shops and universities. Innovative ways to utilize WLAN technology are helping people to work and communicate more efficiently. Increased mobility and the absence of cabling and other fixed infrastructure have proven to be beneficial for many users.

Wireless users can use the same applications they use on a wired network. Wireless adapter cards used on laptop and desktop systems support the same protocols as Ethernet adapter cards.

Under many circumstances, it may be desirable for mobile network devices to link to a conventional Ethernet LAN in order to use servers, printers or an Internet connection supplied through the wired LAN. A Wireless Access point is a device used to provide this link.

What is Wireless?

Wireless or Wi-Fi technology is another way of connecting your computer to the network without using wires. Wi-Fi uses radio frequency to connect wirelessly, so you have the freedom to connect computers anywhere in your home or office.

D-Link is the worldwide leader and award winning designer, developer, and manufacturer of networking products. D-Link delivers the performance you need at a price you can afford. D-Link has all the products you need to build your network.

How does wireless work?

Wireless works similar to how cordless phone work, through radio signals to transmit data from one point A to point B. But wireless technology has restrictions as to how you can access the network. You must be within the wireless network range area to be able to connect your computer. There are two different types of wireless networks Wireless Local Area Network (WLAN), and Wireless Personal Area Network (WPAN).

Wireless Local Area Network (WLAN)

In a wireless local area network, a device called an Access Point (AP) connects computers to the network. The access point has a small antenna attached to it, which allows it to transmit data back and forth over radio signals. With an indoor access point as seen in the picture, the signal can travel up to 300 feet. With an outdoor access point the signal can reach out up to 30 miles to serve places like manufacturing plants, industrial locations, college and high school campuses, airports, golf courses, and many other outdoor venues.

Wireless Personal Area Network (WPAN)

Bluetooth is the industry standard wireless technology used for WPAN. Bluetooth devices in WPAN operate in a range up to 30 feet away.

Compared to WLAN the speed and wireless operation range are both less than WLAN, but in return it doesn't use nearly as much power which makes it ideal for personal devices, such as mobile phones, PDAs, headphones, laptops, speakers, and other devices that operate on batteries.

Who uses wireless?

Wireless technology has become so popular in recent years that almost everyone is using it, whether it's for home, office, business, D-Link has a wireless solution for it.

Home

- Gives everyone at home broadband access
- Surf the web, check email, instant message, etc.
- Gets rid of the cables around the house
- Simple and easy to use

Small Office and Home Office

- Stay on top of everything at home as you would at office
- Remotely access your office network from home
- Share Internet connection and printer with multiple computers
- No need to dedicate office space

Where is wireless used?

Wireless technology is expanding everywhere not just at home or office. People like the freedom of mobility and it's becoming so popular that more and more public facilities now provide wireless access to attract people. The wireless connection in public places is usually called "hotspots".

Using a D-Link Cardbus Adapter with your laptop, you can access the hotspot to connect to Internet from remote locations like: Airports, Hotels, Coffee Shops, Libraries, Restaurants, and Convention Centers.

Wireless network is easy to setup, but if you're installing it for the first time it could be quite a task not knowing where to start. That's why we've put together a few setup steps and tips to help you through the process of setting up a wireless network.

Tips

Here are a few things to keep in mind, when you install a wireless network.

Centralize your access point or Access Point

Make sure you place the bridge/access point in a centralized location within your network for the best performance. Try to place the bridge/access point as high as possible in the room, so the signal gets dispersed throughout your home. If you have a two-story home, you may need a repeater to boost the signal to extend the range.

Eliminate Interference

Place home appliances such as cordless telephones, microwaves, wireless speakers, and televisions as far away as possible from the bridge/access point. This would significantly reduce any interference that the appliances might cause since they operate on same frequency.

Security

Don't let your next-door neighbors or intruders connect to your wireless network. Secure your wireless network by turning on the WPA or WEP security feature on the access point. Refer to product manual for detail information on how to set it up.

Wireless Modes

There are basically two modes of networking:

- **Infrastructure** – All wireless clients will connect to an access point or wireless bridge.
- **Ad-Hoc** – Directly connecting to another computer, for peer-to-peer communication, using wireless network adapters on each computer, such as two or more wireless network Cardbus adapters.

An Infrastructure network contains an Access Point or wireless bridge. All the wireless devices, or clients, will connect to the wireless bridge or access point.

An Ad-Hoc network contains only clients, such as laptops with wireless cardbus adapters. All the adapters must be in Ad-Hoc mode to communicate.

Networking Basics

Check your IP address

After you install your new D-Link adapter, by default, the TCP/IP settings should be set to obtain an IP address from a DHCP server (i.e. wireless router) automatically. To verify your IP address, please follow the steps below.

Click on **Start > Run**. In the run box type **cmd** and click **OK**.

At the prompt, type **ipconfig** and press **Enter**.

This will display the IP address, subnet mask, and the default gateway of your adapter.

If the address is 0.0.0.0, check your adapter installation, security settings, and the settings on your access point. Some firewall software programs may block a DHCP request on newly installed adapters.

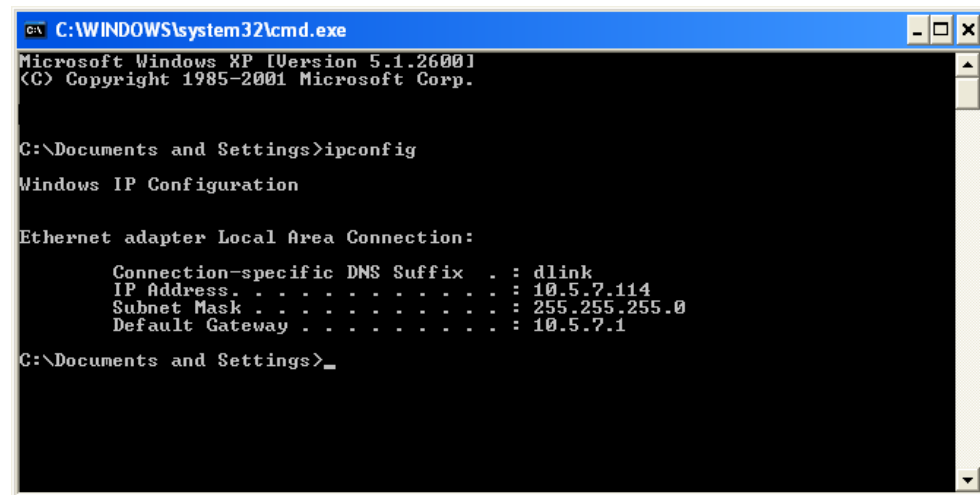

```
C:\WINDOWS\system32\cmd.exe
Microsoft Windows XP [Version 5.1.2600]
(C) Copyright 1985-2001 Microsoft Corp.

C:\Documents and Settings>ipconfig

Windows IP Configuration

Ethernet adapter Local Area Connection:

    Connection-specific DNS Suffix  . : dlink
    IP Address . . . . . : 10.5.7.114
    Subnet Mask . . . . . : 255.255.255.0
    Default Gateway . . . . . : 10.5.7.1

C:\Documents and Settings>_
```

If you are connecting to a wireless network at a hotspot (e.g. hotel, coffee shop, airport), please contact an employee or administrator to verify their wireless network settings.

Statically Assign an IP address

If you are not using a DHCP capable gateway/access point, or you need to assign a static IP address, please follow the steps below:

Step 1

Windows® XP - Click on **Start > Control Panel > Network Connections**.

Windows® 2000 - From the desktop, right-click **My Network Places > Properties**.

Step 2

Right-click on the Local Area Connection which represents your D-Link network adapter and select **Properties**.

Step 3

Highlight **Internet Protocol (TCP/IP)** and click **Properties**.

Step 4

Click **Use the following IP address** and enter an IP address that is on the same subnet as your network or the LAN IP address on your access point.

Example: If the access point's LAN IP address is 192.168.0.1, make your IP address 192.168.0.X where X is a number between 2 and 99. Make sure that the number you choose is not in use on the network. Set Default Gateway the same as the LAN IP address of your access point (192.168.0.1).

Set Primary DNS the same as the LAN IP address of your router (192.168.0.1). The Secondary DNS is not needed or you may enter a DNS server from your ISP.

Step 5

Click **OK** twice to save your settings.

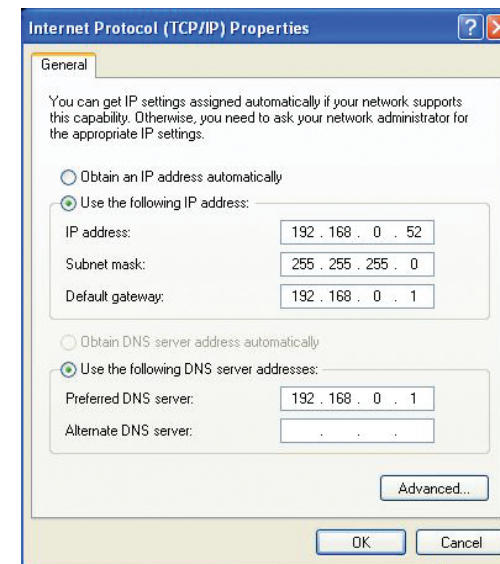

Technical Specifications

Standards

- IEEE 802.11n
- IEEE 802.11a
- IEEE 802.11g
- IEEE 802.11b
- IEEE 802.3
- IEEE 802.3u

Security

- WPA-Personal
- WPA2-Personal
- WPA-Enterprise
- WPA2-Enterprise
- 64/128-bit WEP

Wireless Signal Rates¹

- 300Mbps
- 108Mbps
- 54Mbps
- 48Mbps
- 36Mbps
- 24Mbps
- 18Mbps
- 12Mbps
- 11Mbps
- 9Mbps
- 6Mbps
- 5.5Mbps
- 2Mbps
- 1Mbps

Maximum Operating Voltage

- 3.3V

Maximum Operating Current

- 1435 mA

Modulation

- 11b: DQPSK, DBPSK and CCK
- 11a/g: BPSK, QPSK, 16QAM, 64QAM, OFDM
- 11n: BPSK, QPSK, 16QAM, 64QAM, OFDM, MCS

Frequency Range²

- 2.4GHz to 2.483GHz
- 5.15GHz~5.825GHz³

LEDs

- Power
- Bridge
- AP
- LAN

Operating Temperature

- 32°F to 104°F (0°C to 40°C)

Humidity

- 90% maximum (non-condensing)

Safety & Emissions

- FCC
- CE
- IC
- C-Tick
- CSA

Dimensions

- L = 5.75 inches
- W = 4.5 inches
- H = 1.25 inches

¹Maximum wireless signal rate derived from IEEE Standard 802.11g, 802.11a and Draft 802.11n specifications. Actual data throughput will vary. Network conditions and environmental factors, including volume of network traffic, building materials and construction, and network overhead, lower actual data throughput rate. Environmental conditions will adversely affect wireless signal range.

²Range varies depending on country's regulation.

³The DAP-1522 doesn't include 5.25-5.35GHz & 5.47~5.725GHz.

CE Mark Warning:

This is a Class B product. In a domestic environment, this product may cause radio interference, in which case the user may be required to take adequate measures.

Federal Communication Commission Interference Statement

This equipment has been tested and found to comply with the limits for a Class B digital device, pursuant to Part 15 of the FCC Rules. These limits are designed to provide reasonable protection against harmful interference in a residential installation. This equipment generates, uses and can radiate radio frequency energy and, if not installed and used in accordance with the instructions, may cause harmful interference to radio communications. However, there is no guarantee that interference will not occur in a particular installation. If this equipment does cause harmful interference to radio or television reception, which can be determined by turning the equipment off and on, the user is encouraged to try to correct the interference by one of the following measures:

- Reorient or relocate the receiving antenna.
- Increase the separation between the equipment and receiver.
- Connect the equipment into an outlet on a circuit different from that to which the receiver is connected.
- Consult the dealer or an experienced radio/TV technician for help.

This device complies with Part 15 of the FCC Rules. Operation is subject to the following two conditions: (1) This device may not cause harmful interference, and (2) this device must accept any interference received, including interference that may cause undesired operation.

FCC Caution: Any changes or modifications not expressly approved by the party responsible for compliance could void the user's authority to operate this equipment.

For operation within 5.15 ~ 5.25GHz frequency range, it is restricted to indoor environment.

IEEE 802.11b or 802.11g operation of this product in the U.S.A. is firmware-limited to channels 1 through 11.

IMPORTANT NOTE:

FCC Radiation Exposure Statement:

This equipment complies with FCC radiation exposure limits set forth for an uncontrolled environment. This equipment should be installed and operated with minimum distance 20cm between the radiator & your body.

This transmitter must not be co-located or operating in conjunction with any other antenna or transmitter.

Industry Canada Statement

This device complies with RSS-210 of the Industry Canada Rules. Operation is subject to the following two conditions:

- 1) this device may not cause interference and
- 2) this device must accept any interference, including interference that may cause undesired operation of the device

This device has been designed to operate with an antenna having a maximum gain of 2dBi. Antenna having a higher gain is strictly prohibited per regulations of Industry Canada. The required antenna impedance is 50 ohms.

To reduce potential radio interference to other users, the antenna type and its gain should be so chosen that the EIRP is not more than required for successful communication.

Caution:

The device for the band 5150-5250 MHz is only for indoor usage to reduce potential for harmful interference to co-channel mobile satellite systems.

Because high power radars are allocated as primary users (meaning they have priority) in 5250-5350 MHz and 5650-5850 MHz, these radars could cause interference and/or damage to license exempt LAN devices.

IMPORTANT NOTE:

IC Radiation Exposure Statement:

This equipment complies with IC radiation exposure limits set forth for an uncontrolled environment. This equipment should be installed and operated with minimum distance 20cm between the radiator and your body.

The availability of some specific channels and/or operational frequency bands are country dependent and are firmware programmed at the factory to match the intended destination. The firmware setting is not accessible by the end user.

For detailed warranty information applicable to products purchased outside the United States, please contact the corresponding local D-Link office.