

USER MANUAL

ShareCenter™ Pulse

DNS-320

VERSION 1.0



Table of Contents

Table of Contents	2	Network Shares Page.....	37
Product Overview	4	Adding New Network Shares	38
Package Contents	4	Quotas Page	42
System Requirements	4	FTP Server Page.....	44
Introduction	5	FTP Access Behind a Router.....	46
Features	5	FTP over TLS.....	47
Hardware Overview	7	UPnP AV Server Page.....	51
Front View	7	iTunes Server Page.....	53
Rear View (Connections).....	8	Time Machine Page.....	54
Basic Installation	9	NFS Service Page.....	56
Hardware Setup	9	Maintenance Section	57
Software Setup.....	11	Admin Password Page.....	58
Easy Search Utility	11	System Page.....	59
Getting Started.....	12	Firmware Upgrade Page	61
Web User Interface	17	E-mail Alerts Page.....	62
Setup Section	17	Power Management Page	64
Wizard Page	18	RAID Page	65
LAN Setup Page	22	RAID Configuration - Standard	66
Time and Date Page.....	24	RAID Configuration - JBOD.....	67
Device Page.....	25	RAID Configuration - RAID 0.....	68
Language Page.....	26	RAID Configuration - RAID 1	69
Advanced Section	27	Dynamic DNS Page	71
User / Groups Page	28	Disk Diagnostic Page	72
Adding New Users.....	29	Status Section.....	74
Adding New Groups	33	System Info Page.....	75
		Hard Drive Info Page	76
		Logs Page	77

Support Section	78
Schedule Downloads Section	79
Local Backups Page	80
FTP/HTTP Downloads Page	82
P2P Downloads Section	84
Downloads Page.....	85
Setting Page	86
Ajaxplorer Section	87
Launch Page.....	88
Support Section	89
Knowledge Base	90
Mapping a Drive	90
Replacing or Adding a New Hard Drive.....	91
Secure HTTP Login.....	91
What is RAID?.....	92
RAID 1 - Auto Rebuilding	93
Yahoo! Widget Installation	95
Yahoo! Widget Display.....	96
Technical Specifications	97
Contacting Technical Support.....	98
Warranty	99
Registration.....	103

Product Overview

Package Contents

- D-Link ShareCenter Pulse 2-Bay Network Storage
- CD-ROM with Manual and Software
- Quick Installation Guide
- Power Adapter
- CAT5 Ethernet Cable



Note: Using a power supply with a different voltage than the one included with the ShareCenter Pulse will cause damage and void the warranty for this product.
If any of the above items are missing, please contact your reseller.

System Requirements

For best results, the following system requirements are recommended:

- Computer with: 1GHz processor / 512 MB RAM / 200 MB available space / CD-ROM drive
- Internet Explorer version 7.0 or Mozilla Firefox 3.0 and above
- 3.5" SATA Hard Drive(s)
- Windows® XP (with Service Pack 2), Vista™ or Windows 7.

Introduction

The D-Link ShareCenter Pulse, 2-Bay Network Storage shares your documents, photos, music, and videos across the Internet so family members, friends, or employees can access them. This enclosure, which can hold two 3.5" SATA hard drives of any capacity, creates a central point for backing up valuable files. The built-in RAID 1 mirroring technology protects these files from drive failure. Other options such as Standard, JBOD, and RAID 0 are also available.

The ShareCenter Pulse shares files over the Internet via the built-in FTP server or the built-in AjaXplorer web file server. Users and groups can be created and assigned to folders with either read or read/write permissions. Quotas can be set per user or group to restrict space usage. In addition, the ShareCenter Pulse can be used to stream photos, music, and videos to UPnP AV compatible network media players.

The included CD contains D-Link's Easy Search Utility. This utility allows you to locate the ShareCenter Pulse on the network and map drives to your computer. Backup software included on the CD allows you to backup your files from a computer to the ShareCenter Pulse manually, by a schedule, or in real-time. Real-time backups are a great way to safeguard against unfortunate accidents that may result in the loss of important files.

Combining ease of use with practical and high performance features, the ShareCenter Pulse is an organized solution for any network. Free up drive space on computers and centralize data on your network with the ShareCenter Pulse 2-Bay Network Storage!

Features

The ShareCenter Pulse is designed for easy installation and allows remote access to important data via LAN or WAN:

- Two Hard Drive Bays for 3.5" SATA Hard Drives up to 4TB
- Simplified Hard Drive Installation Process
- Four Hard Drive Configurations: Standard, JBOD (Linear), RAID 0, and RAID 1
- High Performance Gigabit Ethernet Connectivity
- Scheduled Downloads from Web or FTP Sites
- Full or Incremental Backups
- Built-in FTP Server supports FTP over SSL/TLS and FXP
- Real Time Backups With the Included Backup Software
- Users and Groups Can Be Assigned to Folders with Read or Read/Write Permissions
- Quotas For Users and Groups
- Automatic E-Mail Notifications
- Power Management for Conserving Energy and Extending Hard Drive Life
- UPnP AV Server for Streaming Music, Photos, and Video to Compatible Media Players
- iTunes® Software will be able to automatically find and play music directly from the ShareCenter Pulse
- D-Link Easy Search Utility
- Configurable by Web Browser
- Supports HTTPS management function
- Supports Configuration file save/load
- Supports DDNS
- Supports multi-language packages
- Supports UPnP
- Supports PnP-X / LLTD
- Supports Uni-code for both Samba and FTP Server
- Supports P2P Download
- Supports Yahoo! Widget
- Support NFS/AFP Server.
- Support Auto Power Recovery

- Support System Logging/FTP Logging
- Support Remote File Access via Built-in AjaXplorer or via FTP Server
- Support Apple Time Machine
- USB port support External Storage Device, Printer Server, UPS Monitoring
- Support USB Copy Function
- Support RAID Migration: Standard to RAID1
- Support Local Backup

Hardware Overview

Front View

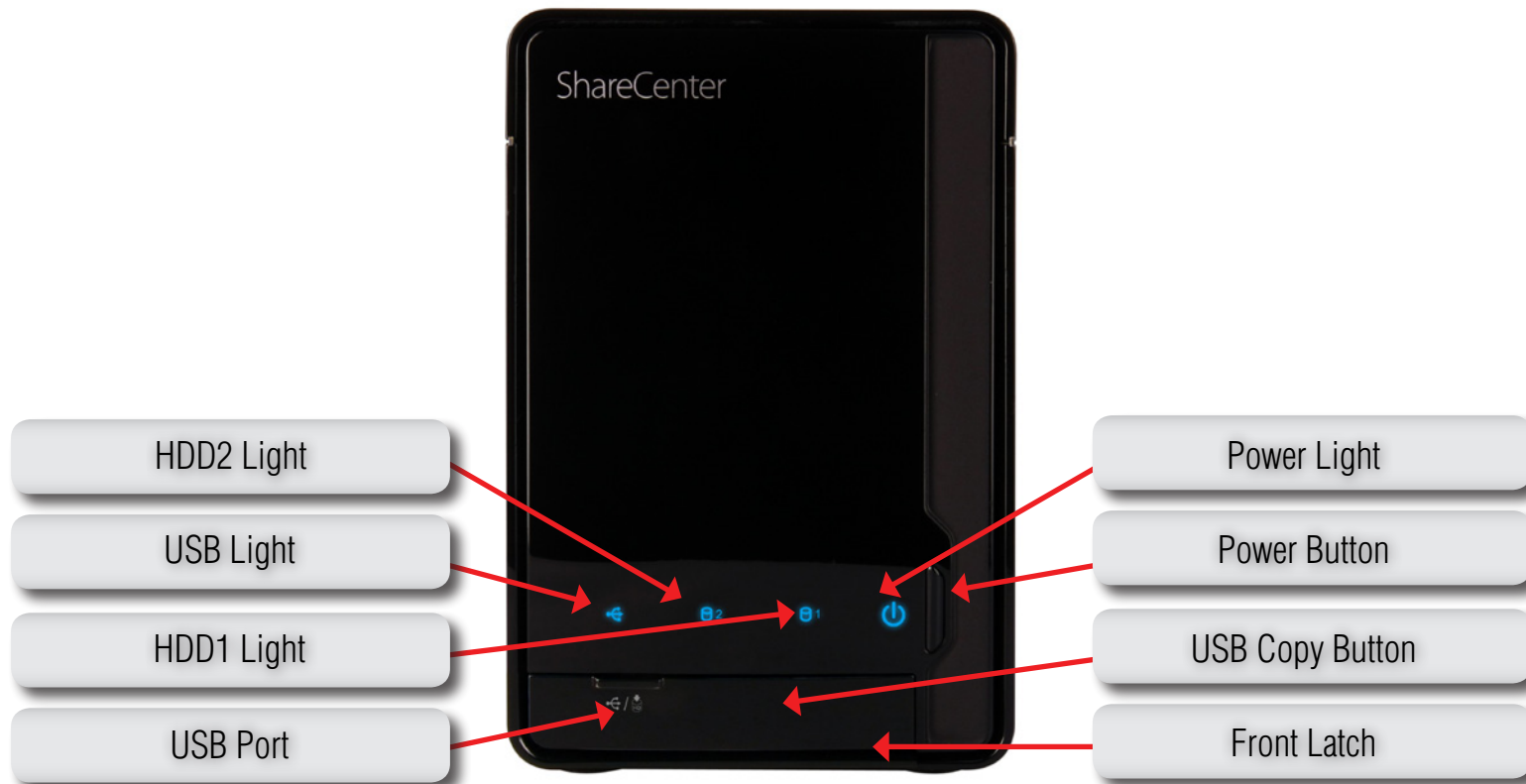

- HDD1/HDD2 Light:** These lights will be solid BLUE when drives are connected but inactive. The lights will blink when the drives are being accessed, formatted or synchronized. They will illuminate AMBER if a drive has failed.
- USB Light:** This light will illuminate when a USB device is inserted into the USB Port. When there's traffic this light will blink.
- USB Port:** This is the USB Port. Devices like a USB Print Server, UPS or USB drive can be inserted here.
- Power Light:** This light will illuminate when this ShareCenter Pulse is powered on.
- Power Button:** Press this button once to power on the ShareCenter Pulse. Press and hold the button until it begins to blink to power down the ShareCenter Pulse.
- USB Copy Button:** Press this button to copy data from USB drive to ShareCenter Pulse. Press and hold 5 seconds to un-mount USB drive.
- Front Latch:** This latch can open and close by simply pressing it.

Rear View (Connections)

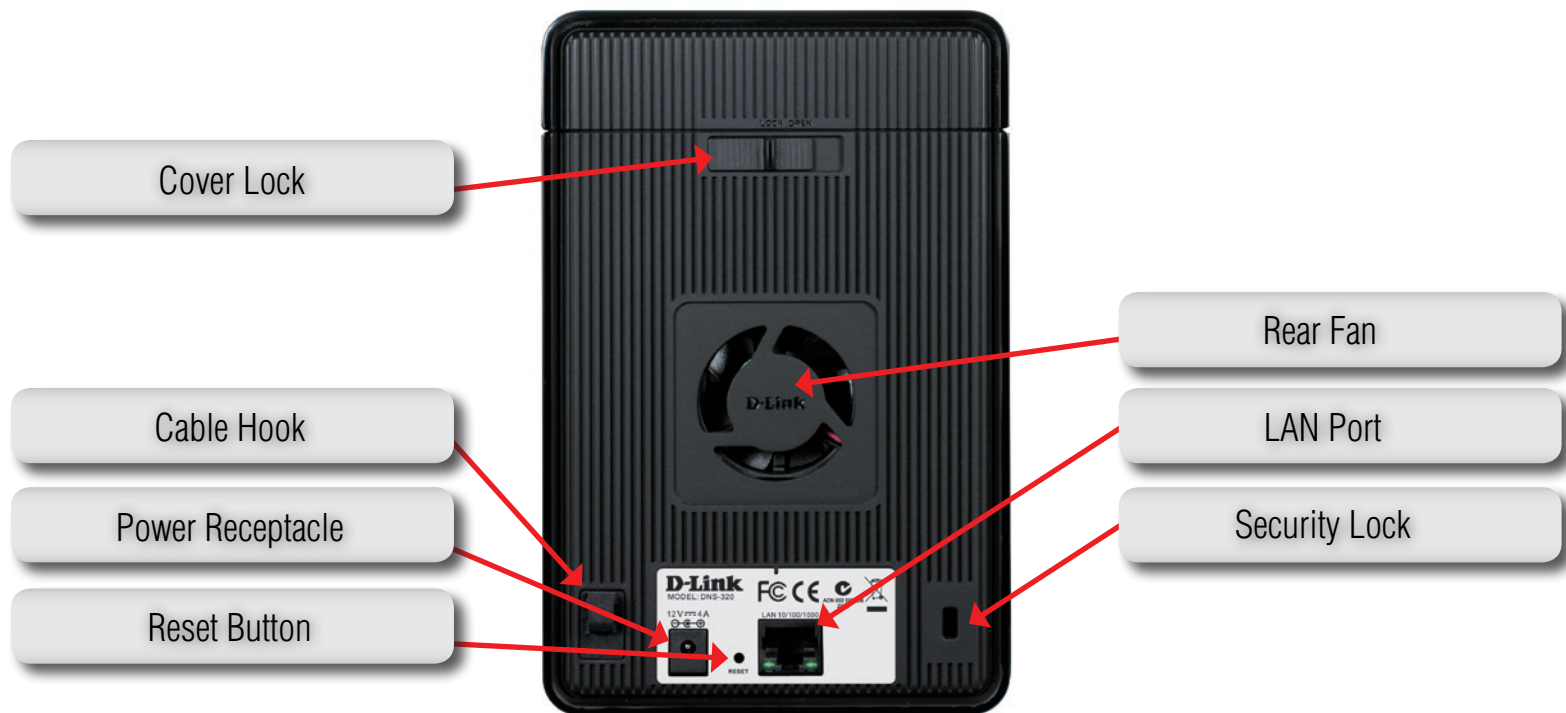

Cover Lock: This lock is used to remove the cover when unlocked. Locking it will restrict the removal of the top cover.

Cable Hook: This hook can be used to neatly store the cables connected to the ShareCenter Pulse.

Power Receptacle: The supplied power adapter connects here.

Reset Button: A pinhole button located beside the Ethernet socket is used to reset the system or restore the factory default settings.
Note: After resetting the unit you will still be able to access the data on your hard drives.

Rear Fan: This is the rear fan used for ventilation.

LAN Port: A Gigabit Ethernet port that connects the ShareCenter Pulse to a network.

Security Lock: This lock can be used to tie the ShareCenter Pulse to the desk to prevent theft. Cables are sold separately.

Basic Installation

Hardware Setup

This section provides installation information for the ShareCenter Pulse. To install the ShareCenter Pulse on your local network, refer to the steps below:



1. To remove the top cover you have move the cover lock to the right.



2. While holding the cover lock, slide the top cover backwards. After sliding the top cover backwards, lift the top cover up to remove it.



3. Insert a 3.5" SATA hard drive into an available drive bay.



4. Re-attach the top cover.



5. Connect an Ethernet cable to the available Ethernet port. This cable should connect the ShareCenter Pulse to your local network via a router or switch, or directly to a computer for configuration.



6. Connect the power adapter to the power receptacle.

Make sure to align the drive connector to the SATA connector on the bottom edge inside the drive bay of the ShareCenter Pulse. Gently push the drive in until it connects. When a drive is inserted properly, you will feel it “seat” into the connector. Some hard drives that are thin or oddly shaped may need to be guided carefully into position. If a drive is not properly seated, the light will not illuminate after powering on the device.

Software Setup

Easy Search Utility

When first powered on, during the initial boot sequence, the ShareCenter Pulse will wait to be assigned an IP address via DHCP. It is recommended that you use the included D-Link Easy Search Utility when accessing and configuring the ShareCenter Pulse for the first time. If you want to change the IP address before logging in, or if you are unable to connect to the ShareCenter Pulse IP address, you can use the Easy Search Utility provided on the product CD to locate the device on your network and make any needed changes.

- Network Storage Device:** The Easy Search Utility displays the available ShareCenter Pulse devices on the network.
- Refresh:** Refreshes the device list.
- Configuration:** Click Configuration to access the Web-based configuration utility of the ShareCenter Pulse.
- LAN:** Configure the LAN Settings for the ShareCenter Pulse here.
- Apply:** Click Apply to save changes to the LAN Settings.
- Drive Mapping:** Volumes available for mapping are displayed here.
- Available Drive Letters:** Choose an available drive letter. Click Connect to map the selected volume. Click Disconnect to disconnect the selected mapped volume.
- Exit:** Click Exit to close the utility.

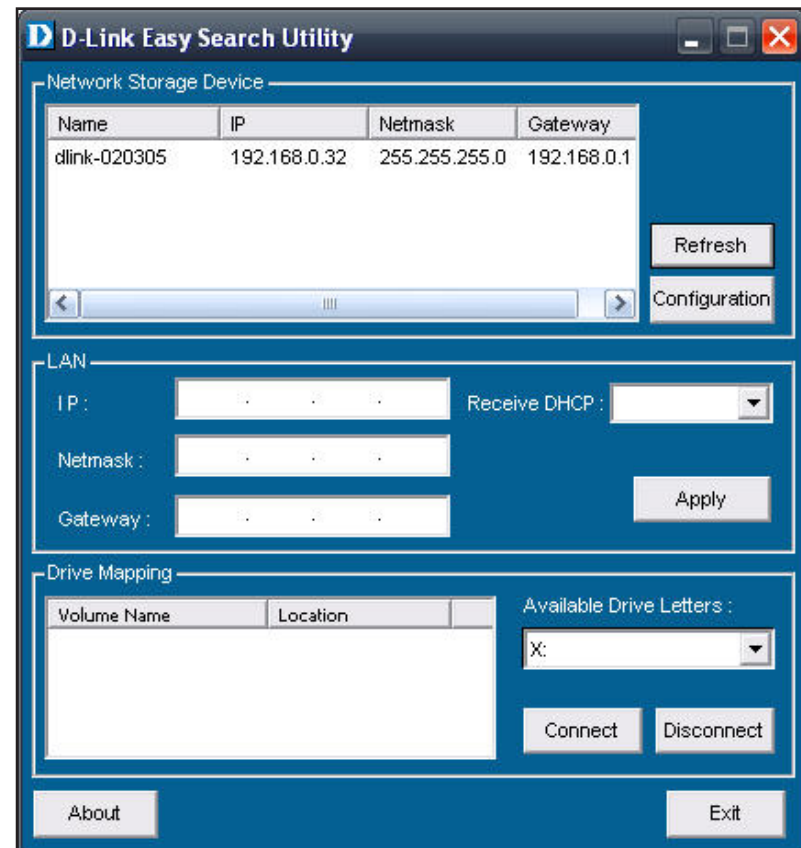

Getting Started

To run the Easy Search Utility, insert the ShareCenter Pulse CD into your CD-ROM drive:

Step 1: Click Easy Search Utility.

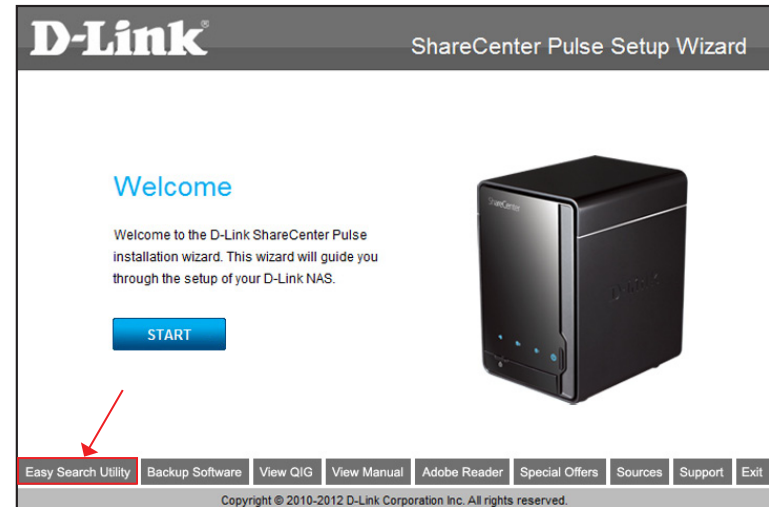

Step 2: Highlight an available ShareCenter Pulse and click Configuration to access the web-based utility.

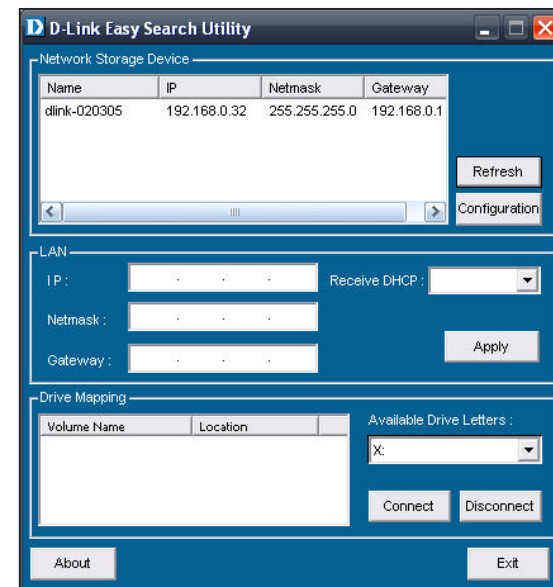

Step 3: The Login screen will appear: Type 'admin' for the username and leave the password field blank.

Click on the **Configuration** button.

Step 4: When logging in to this unit for the first time, the user will be prompted to format the HDD in the device. In this window, information about the HDDs inserted will be displayed. Click **Next** to continue to the next step.

Please note that the data stored on the drives will be erased during this process.

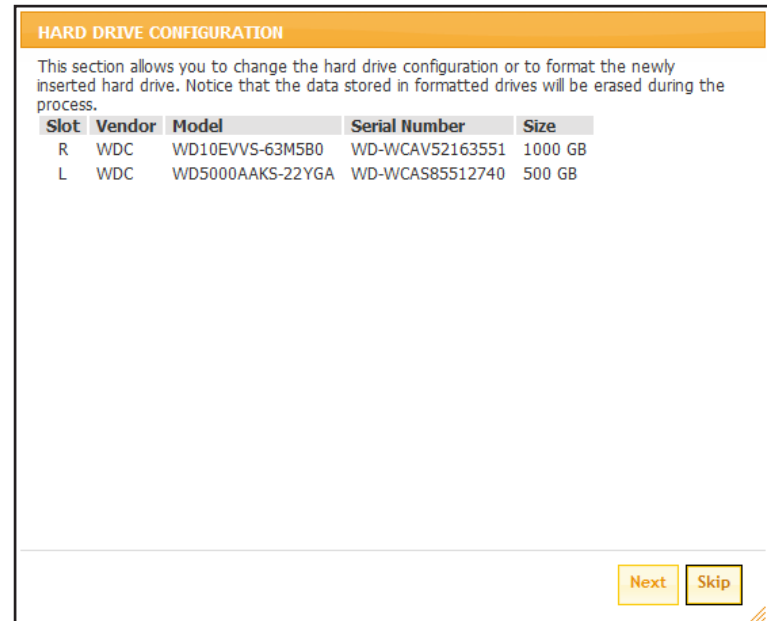
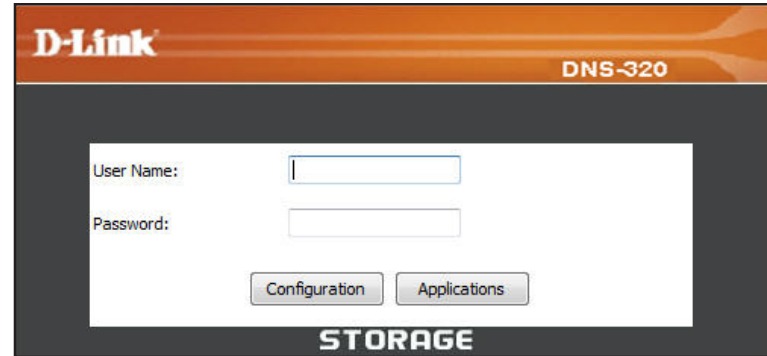

Step 5: The four options are: Standard, JBOD, RAID 0 and RAID 1.

JBOD - Combines both hard drives in a linear fashion which will create one large volume geared towards maximum available space.

RAID 0 - Combines both hard drives in a striped fashion which will create one large volume geared towards maximum performance.

RAID 1 - Mirrors the hard drives for redundancy. If one hard drive fails, the other still contains all of the data. Replace the failed hard drive and it will re-mirror, restoring data protection.

Standard - Creates two separate volumes (or one volume if only one hard drive is present). Each hard drive is its own volume.

When prompted to configure the Hard Drive Settings: Select the type of hard drive configuration. In this configuration we'll use RAID 1 as the example configuration.

Step 6: Auto-rebuild is a feature that allows the ShareCenter Pulse to initiate the rebuilding phase automatically. The rebuilding phase will occur when one or more hard drives fail and is replaced by a new one.

WARNING - This feature will automatically format the newly added drive. If this feature is NOT required, click disable.

Click '**Next**' to continue.

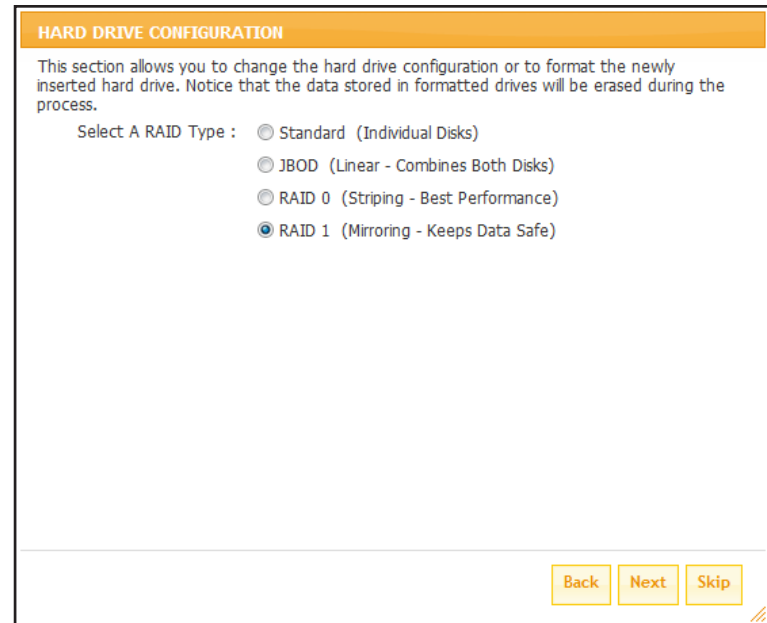

HARD DRIVE CONFIGURATION

This section allows you to change the hard drive configuration or to format the newly inserted hard drive. Notice that the data stored in formatted drives will be erased during the process.

Select A RAID Type :

- Standard (Individual Disks)
- JBOD (Linear - Combines Both Disks)
- RAID 0 (Striping - Best Performance)
- RAID 1 (Mirroring - Keeps Data Safe)

Back Next Skip

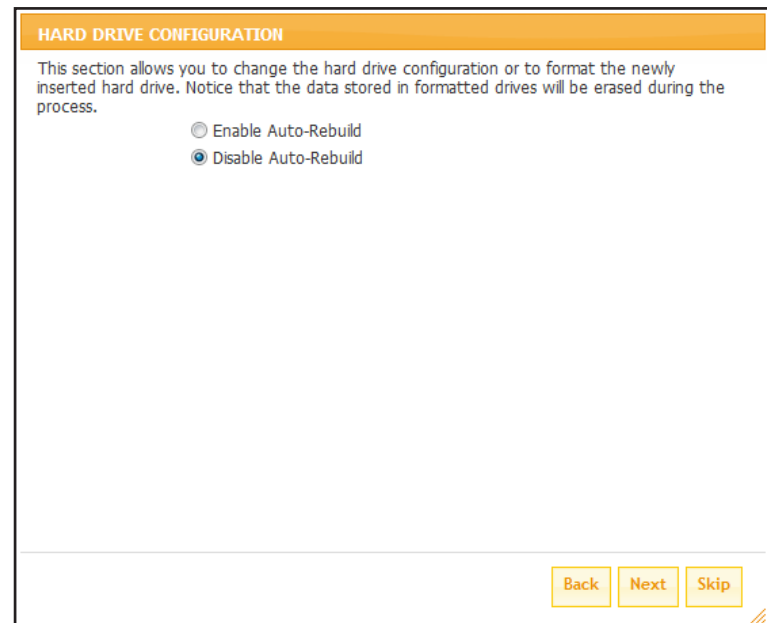

HARD DRIVE CONFIGURATION

This section allows you to change the hard drive configuration or to format the newly inserted hard drive. Notice that the data stored in formatted drives will be erased during the process.

- Enable Auto-Rebuild
- Disable Auto-Rebuild

Back Next Skip

Step 7: In this section the user can view the available capacity that RAID 1 can use on the hard drives installed.

Then the user can configure the desired capacity to be used for the RAID 1 configuration by entering the desired capacity amount in the block provided.

To utilize the remaining space, (if the two HDDs differ in capacity), the user can choose to use JBOD for the remaining space. Tick this option is needed.

Click **'Next'** to continue.

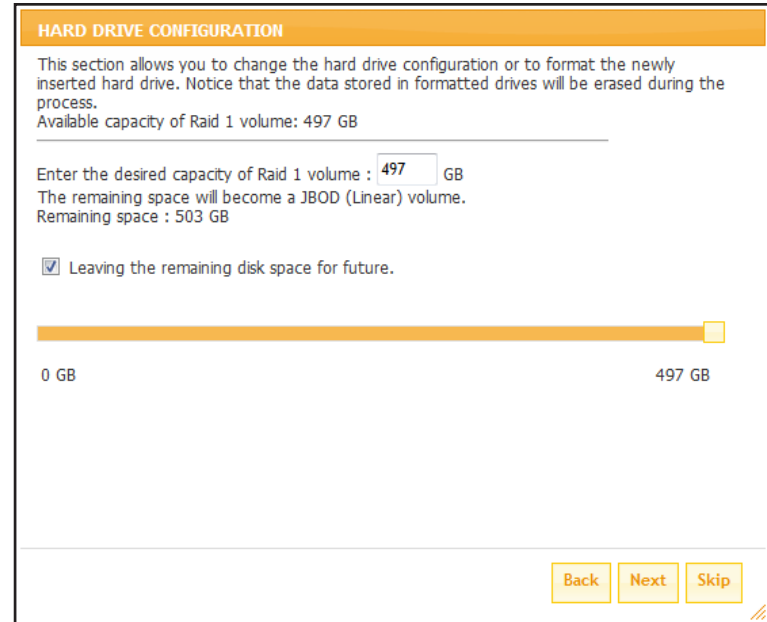

Step 8: In this section a summary of the configuration will be displayed.

When ready click on the **'Format'** button to initiate the RAID configuration. This process will involve initializing, formatting and configuration of the RAID chosen.

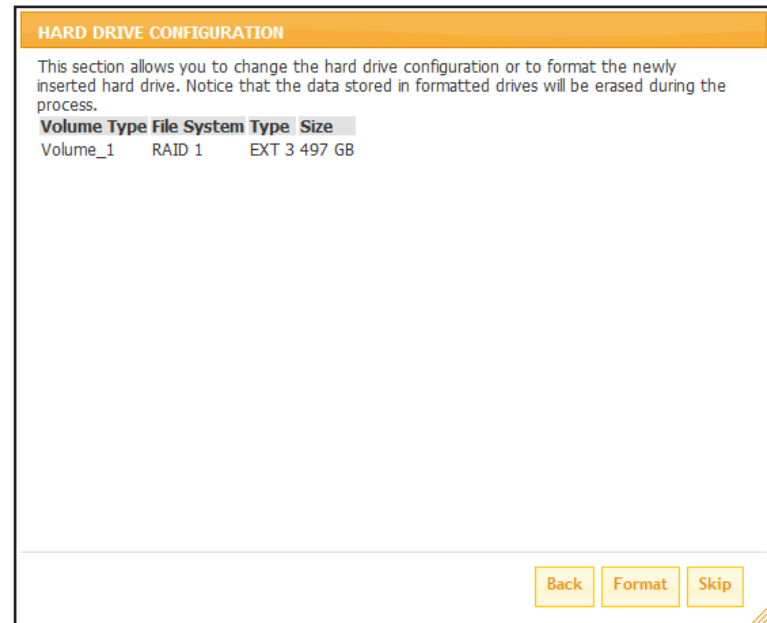

A warning message will be displayed before the procedure starts stating that hard drives will be formatted and if the user wishes to continue. Click '**OK**' to continue.

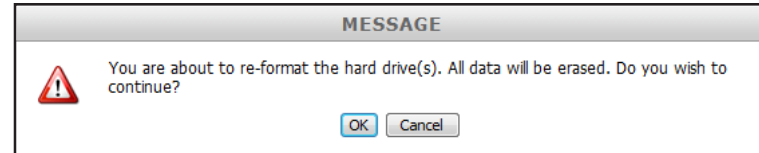

This RAID configuration starts with Initializing.

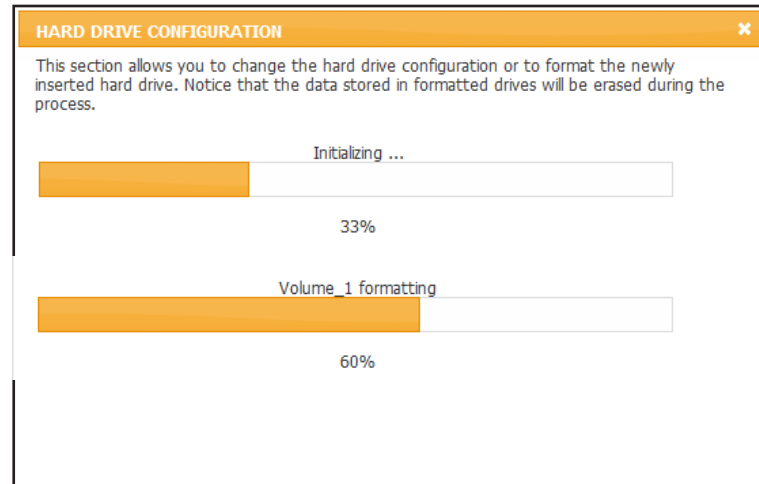

Then continues to format and configure the RAID configuration.

Step 9: Lastly a configuration summary will be displayed.

Click in the '**Finish**' button to complete the setup procedure. This will redirect the user to the Login screen again.

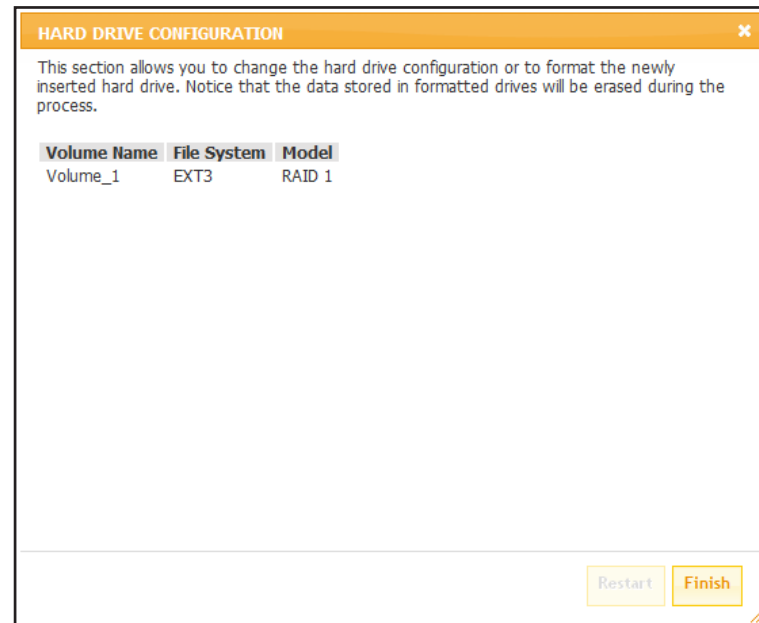

Web User Interface Setup Section

Wizard: On the Wizard page the user can configure some basic settings for this device. The Storage Enclosure, provides a convenient and safe location on the network for storing data and media.

LAN Setup: On the LAN Setup page the user can configure the Link Speed and to the IP address as a DHCP client or Static IP.

Time and Date: On the Time and Date page the user can configure several different options concerning the device's internal clock. It is important that an accurate time is set so that scheduled backups and downloads will be accurate.

Device: On the Device page the user can configure the workgroup, name, and description for this device.

Language: On the Language page the user can upload a language pack file that allows the user to view the web interface for this device in any of the languages available.

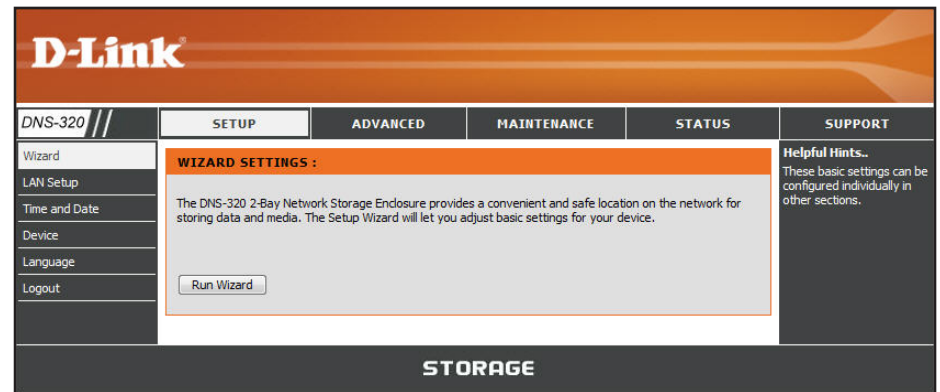

Wizard Page

The storage device has a setup Wizard that allows you to quickly configure some of the basic device settings.

Click on the 'Run Wizard' button to start the setup wizard quick configuration.

Step 1: In this window the user will be informed about the steps that will follow in this configuration.

These steps are:

- 1) Configuring the login password for this device.
- 2) Configuring the time zone used by this device.
- 3) Configuring the LAN Connection settings.
- 4) Configuring E-mail settings.
- 5) Displaying a summary.

Click the 'Next' button to continue to the next step.
Click the 'Exit' button to return to the main page.

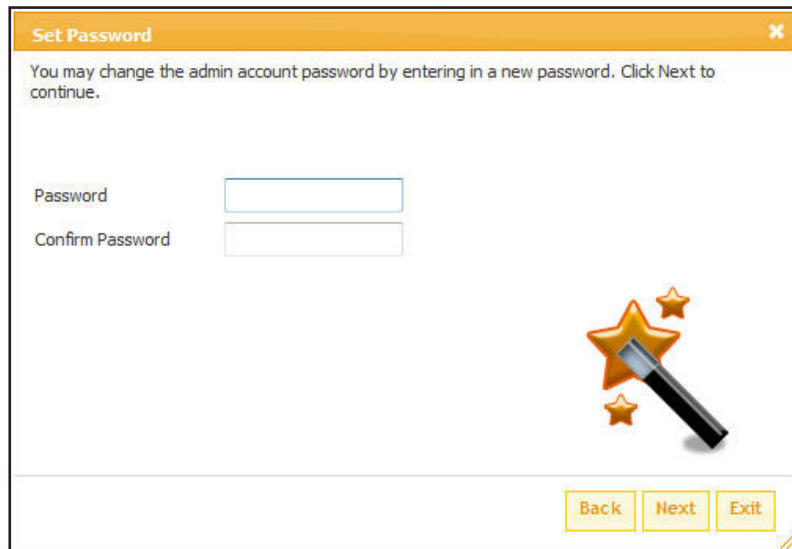
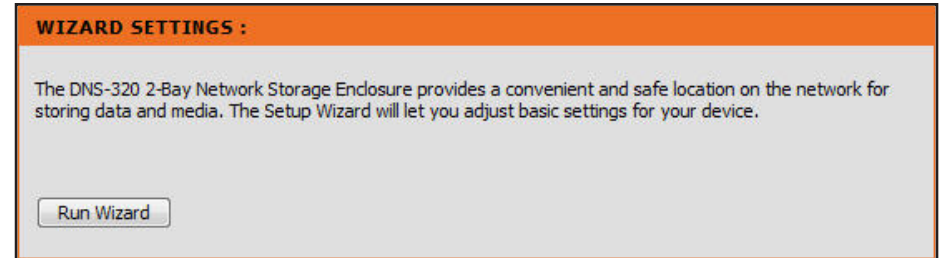
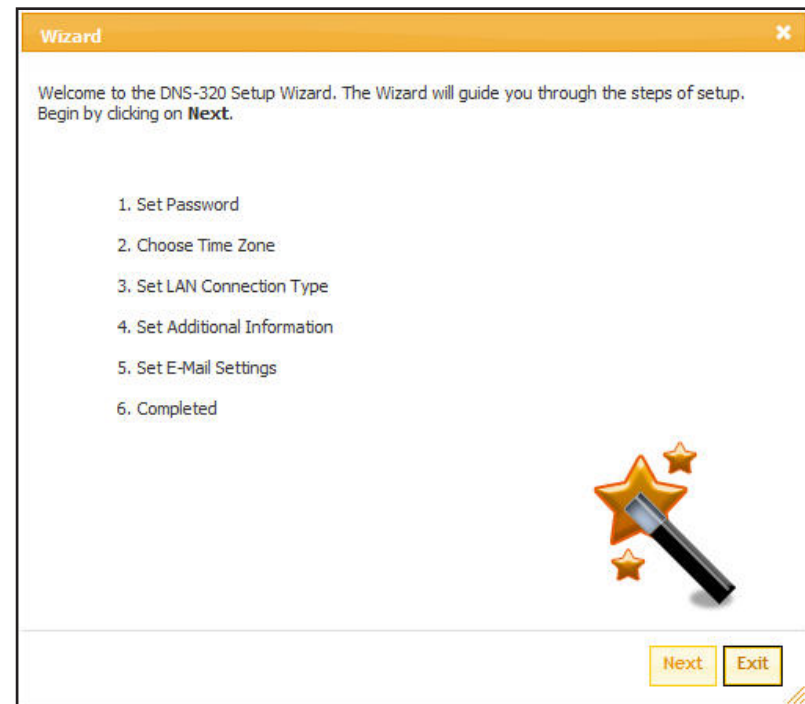
Step 2: In this window the user must enter a new login password used by this device. Enter and confirm the password in the given spaces.

Click the 'Next' button to continue to the next step.
Click the 'Back' button to return to the previous window.
Click the 'Exit' button to return to the main page.

Step 3: In this window the user must choose the Time Zone that will be used for this device from the drop-down menu.

Click the 'Next' button to accept the changes and continue to the next step.

Click the 'Back' button to discard the changes and return to the previous window.

Click the 'Skip' button to forward to the next step

Click the 'Exit' button to return to the main page.

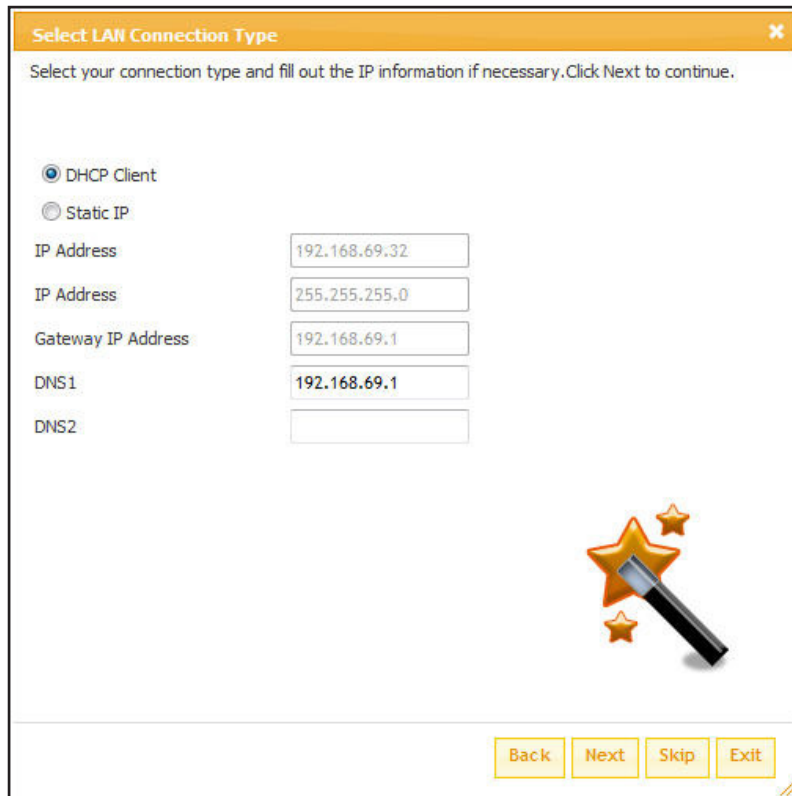

Select LAN Connection Type

Select your connection type and fill out the IP information if necessary. Click Next to continue.

DHCP Client
 Static IP

IP Address: 192.168.69.32
IP Address: 255.255.255.0
Gateway IP Address: 192.168.69.1
DNS1: 192.168.69.1
DNS2:

Back Next Skip Exit

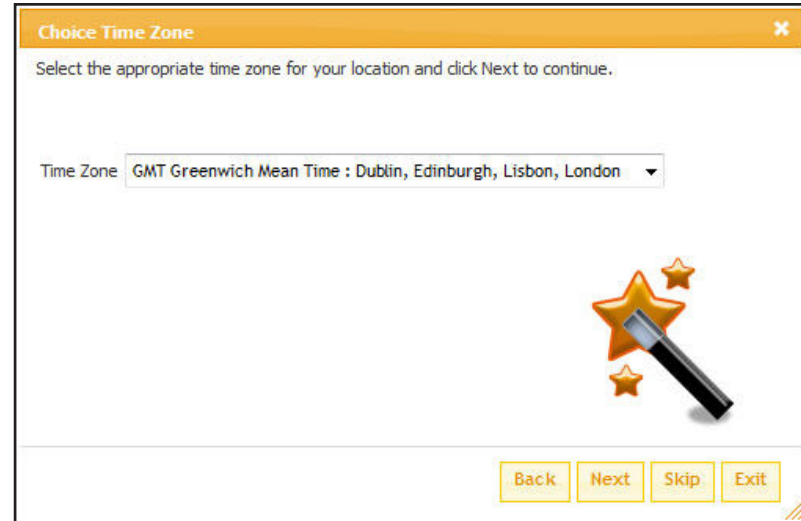

Choice Time Zone

Select the appropriate time zone for your location and click Next to continue.

Time Zone: GMT Greenwich Mean Time : Dublin, Edinburgh, Lisbon, London

Back Next Skip Exit

Step 4: In this window the user can configure the LAN connection settings used by this device. Selecting DHCP Client will cause the ShareCenter Pulse to obtain an IP address from the local DHCP server, such as your router. Selecting Static IP requires you to assign the IP information for the ShareCenter Pulse manually.

Click the 'Next' button to accept the changes and continue to the next step.

Click the 'Back' button to discard the changes and return to the previous window.

Click the 'Skip' button to forward to the next step

Click the 'Exit' button to return to the main page.

Step 5: In this window the user can configure the Workgroup settings used on this device.

Click the 'Next' button to accept the changes and continue to the next step.

Click the 'Back' button to discard the changes and return to the previous window.

Click the 'Skip' button to forward to the next step

Click the 'Exit' button to return to the main page.

Enter your Name for the if necessary. Otherwise you may accept the default values and click Next to continue.

Login Method Account Anonymous

User Name

Password

Port

SMTP Server

Sender E-mail

Receiver E-mail

SMTP Authentication

Enter your Name for the if necessary. Otherwise you may accept the default values and click Next to continue.

Workgroup

Name

Description

Step 6: In this window the user can configure the e-mail account settings used by this device.

Click the 'Next' button to accept the changes and continue to the next step.

Click the 'Back' button to discard the changes and return to the previous window.

Click the 'Skip' button to forward to the next step

Click the 'Exit' button to return to the main page.

Step 7: In this window the user will be informed that the setup wizard is complete and to finish the setup must click on the 'Completed' button.

Click the 'Completed' button to accept the changes and continue with the restart.

Click the 'Back' button to discard the changes and return to the previous window.

Click the 'Exit' button to return to the main page.

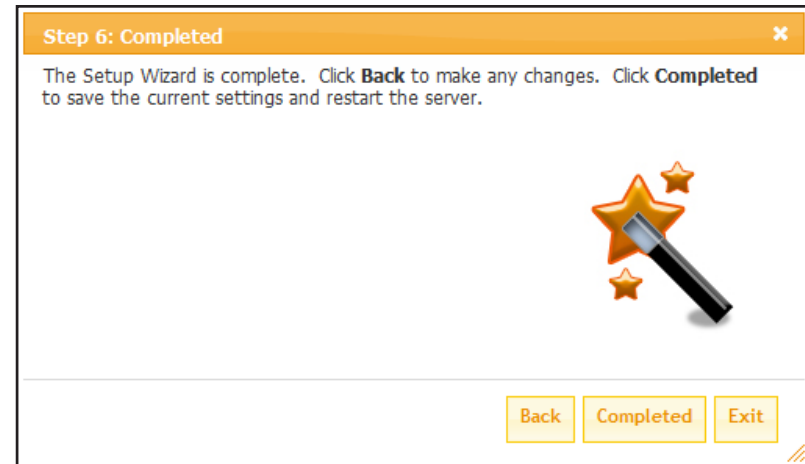

LAN Setup Page

The LAN Settings allows you to configure the Link Speed and to configure the IP address as a DHCP client or Static IP.

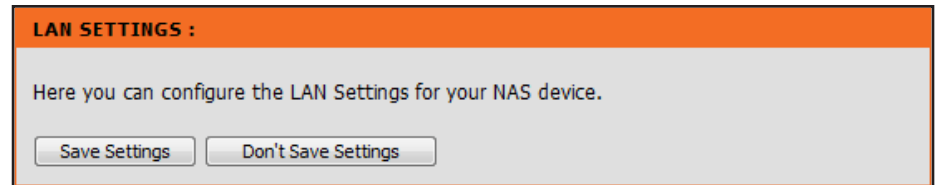

LAN SETTINGS :

Here you can configure the LAN Settings for your NAS device.

DHCP Client: By selecting 'DHCP Client', the ShareCenter Pulse will act as a DHCP client and obtain its LAN IP settings from the DHCP (Dynamic Host Configuration Protocol) server on the local network. By default, the ShareCenter Pulse is set to obtain an IP address from a DHCP server on your network.

Static IP: If necessary, you can assign a static IP address to the ShareCenter Pulse.

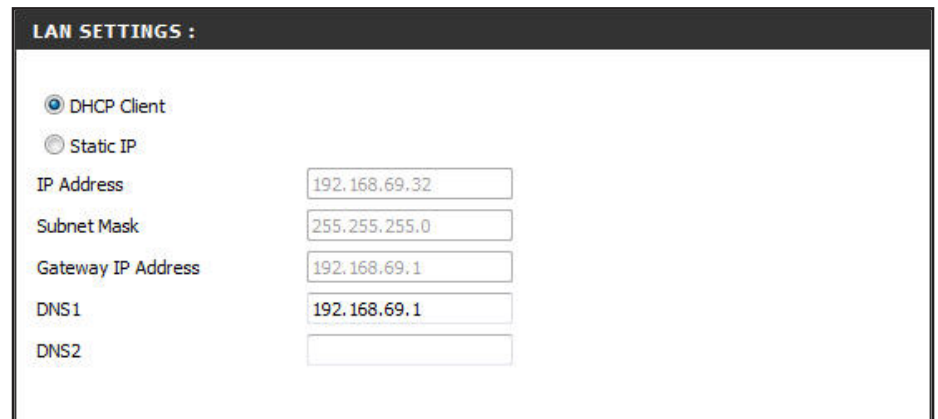

LAN SETTINGS :

DHCP Client
 Static IP

IP Address

Subnet Mask

Gateway IP Address

DNS1

DNS2

IP Address: The IP address of each device on the local area network must be within the same IP address range and subnet mask. For a small subnet with less than 253 IP addresses assigned (e.g. Class C private IP), each device on the LAN (Local Area Network) needs have a unique IP Address in the format of (example) 192.168.0.x to connect to other devices within the same network.

Subnet Mask: Specify the subnet mask for the ShareCenter Pulse. The Subnet mask must be the same for all devices on the same subnet of the network. The default subnet setting is 255.255.255.0. For a small subnet with less than 253 IP addresses assigned (e.g. Class C private IP), keep this default setting.

Gateway IP Address: Specify the Gateway IP Address for the ShareCenter Pulse. The Gateway IP Address is almost always the LAN address of your router. Most D-Link routers have a default LAN IP address of 192.168.0.1.

DNS1: Specify the first and second DNS Addresses for the ShareCenter Pulse. A DNS Address will allow the ShareCenter Pulse to resolve names into IP addresses. Example: Without a DNS address, the ShareCenter Pulse would not be able to contact an FTP site such as ftp.dlink.com (name).
DNS2: Instead, you would need to use 64.7.210.131 (IP address). It is recommended that you enter DNS addresses when setting a Static IP Address. Often you can use the LAN IP address of your router as a DNS address. Click 'Save Settings' when finished.

LLTD: The ShareCenter Pulse supports LLTD (Link Layer Topology Discovery) and is used by the Network Map application that is included in Windows Vista™ and Windows 7™.
Select to enable or disable LLTD on your ShareCenter Pulse.



Time and Date Page

The Time configuration option allows you to configure, update, and maintain the correct time on the internal system clock. In this section you can set the time zone that you are in, and set the NTP (Network Time Protocol) Server in order to periodically update your system time from the NTP Server. You can also use your computer's time as the system time.

Manually: Enter the complete time and date settings manually. Click 'Save Settings' to apply these settings. To synchronize the device clock with your computer, click the 'Set time from my computer' button.

Time Zone: Select your time zone from the drop-down menu. Click 'Save Settings' after selecting your time zone.

NTP Server: Network Time Protocol (NTP) synchronizes the device with an Internet time server. D-Link provides two time server for your convenience. Choose the one closest to your location.

Click 'Save Settings' to accept these changes.

SYSTEM TIME SETTINGS:

The Time configuration option allows you to configure, update, and maintain the correct time on the internal system clock. In this section you can set the time zone that you are in, and set the NTP (Network Time Protocol) Server in order to periodically update your system time from the NTP Server. You can also use your computer's time as the system time.

Current Time : 03:42:50 PM 07/23/2010

Current Time Zone :GMT Casablanca, Monrovia

SET THE DATE AND TIME MANUALLY :

Date: 07/23/2010 Time: 15 : 42 : 46

Set time from my computer Save Settings

TIMEZONE :

Time Zone: GMT Casablanca, Monrovia

Save Settings

NTP SERVER :

NTP Server ntp1.dlink.com << ntp1.dlink.com

Save Settings

Device Page

The device settings page allows you to assign a workgroup, name and description to the device. You can access this device by typing the host name in the URL section of your web browser. For example: `http://dlink-d10001`

Workgroup: Enter your Workgroup name here. The workgroup name should be the same as the computers on the network. Devices using the same workgroup will have additional file sharing methods available.

Name: Enter your device Name here. This name is what the ShareCenter Pulse will appear as on the network. By default, the device name is `dlink-xxxxxx`, where `xxxxxx` is the last six digits of the MAC address.

Description: Assign a device description to the device.

Click 'Save Settings' to accept these changes.

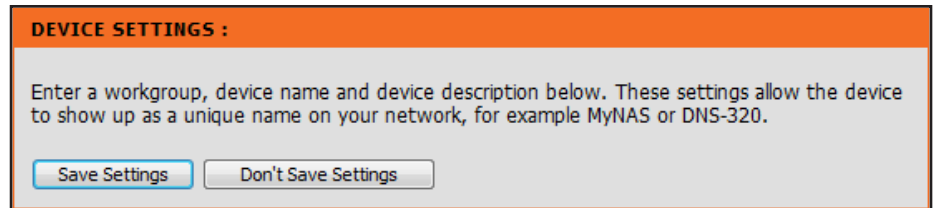

DEVICE SETTINGS :

Enter a workgroup, device name and device description below. These settings allow the device to show up as a unique name on your network, for example MyNAS or DNS-320.



DEVICE SETTINGS :

Workgroup	<input type="text" value="workgroup"/>
Name	<input type="text" value="dlink-d10001"/>
Description	<input type="text" value="DNS-320"/>

Language Page

This page allows you to install language packages onto your system to suit your local language needs.

Language Pack: Click on “Browse” to search for the specific language pack you want to install. After selecting the language pack, then click “Apply” to install the language pack.

Summary: In the summary section the loaded language packs will be displayed and can be enabled at will by simply clicking the (>) play button. More than one language pack can be installed, but only one language pack can be used at a time.



Please Note:

Keep a keen lookout on D-Link's local website for new Language Packs.

LANGUAGE SETTINGS :

This section allows you to install language packages onto your system. In addition, you can also install language packages to suit your local language needs.

LANGUAGE PACK :

File Path:

SUMMARY :

No.	Module Name	Version	Status	Start/Stop	Dele
No items					

10 Page 1 of 1 No items

Advanced Section

User / Groups: The section allows you to create and manage user accounts and groups. Here you can set user and group privileges for specific shared folders. Up to 64 users and 10 groups can be created.

Network Shares: The Network Shares page allows the user to configure shared folders and rights to specific users and groups.

Quotas: This section allows you to assign a quota to a group or user to limit the amount of storage they are allocated. By default, users and groups do not have a quota.

FTP Server: This section allows you to configure the settings of the built-in FTP server.

UPnP AV Server: This section allows you to configure the UPnP AV server. You can enable or disable the UPnP AV service, and specify the folder or directory that will be shared.

iTunes Server: This section allows you to configure the iTunes server. You can enable or disable the iTunes service, set the password for the service, and specify the folder or directory that will be shared.

Time Machine: This section allows the user to configure the ShareCenter Pulse so that it becomes a backup destination in the Mac OS X Time Machine. In order to use this function, the AFP service is required. The AFP service will start automatically as soon as this function is enabled.

AFP Service: Here the user can enable the AFP Service option. If the Time Machine option is used, this option should be enabled automatically.

NFS Service: Here the user can enable the NFS Service option.



User / Groups Page

The Users / Groups menu is used to create and manage user and group accounts. Up to 64 users and 10 groups can be created. By default, all users have read and write access to all folders but access rules can be created in the Network Shares menu.



User Settings: Users and Groups can be created here. Users' accounts can be added to rules in the Network Shares and FTP Server sections. Each user created will also have access to the Scheduled Download section. Once a group has been created, it will be available in the Group selection on the Users page. The created groups will appear in a list near the bottom of this page. Users within these groups will also be displayed.

Group Settings:

GROUP SETTINGS :

 Add
  Modify
  Delete



Group Name	User Name
group1	user 1

 10 ▾
  Page 1 of 1
  Displaying 1 to 1 of 1 items



USERS / GROUPS SETTINGS :

This section allows you to create unique users and groups for accessing your NAS device. You can create usernames for individual access as well as combine users into a group to limit storage quotas.

USER SETTINGS :

 Add
  Modify
  Delete

User Name	Group Name
user 1	

 10 ▾
  Page 1 of 1
  Displaying 1 to 1 of 1 items

To add a user or a group click on the 'Add' button. To modify an existing user or group click on the 'Modify' button. To remove a user or a group click on the 'Delete' button.

To select a user or a group, simply click on the user or group and the entry should change to a red color that indicates it's selected for use.

At the bottom the user can navigate through pages and also refresh the window by click on the 'Refresh' button.

Adding New Users

The following section will describe how to add a new user on this device. To add a user click on the 'Add' button. A easy to configure wizard will be launched and look like the following:

Start: This window welcomes the user to the setup wizard for adding or modifying a user. This wizard will guide the user through the steps of setup.

In this wizard the user will be able to:

- 1) Create a new user account.
- 2) Join the user to a group.
- 3) Configure the appropriate network shares settings.
- 4) Configure the user quota.
- 5) View a summary of the configuration before completing the addition.

Click on the 'Next' button to continue.

Click on the 'Exit' button to discard the changes made and return to the User/Group window.

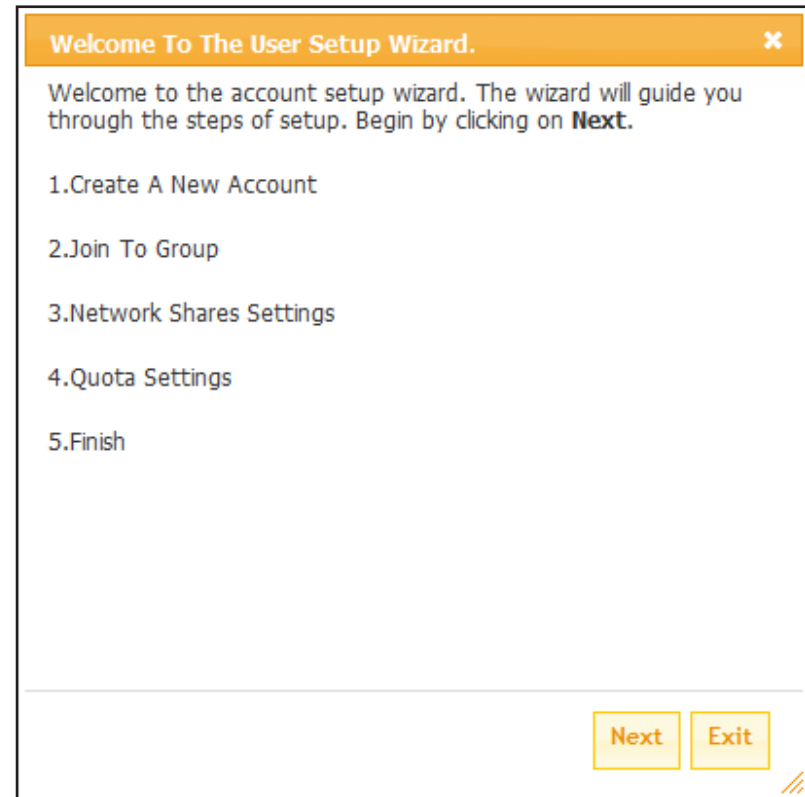

Step 1: Here the user can enter the User Name and Password for the new user account. The password needs to be confirmed by re-entering the password in the Confirm Password field.

Click on the 'Back' button to return to the previous window.
Click on the 'Next' button to accept the change and continue to the next window.

Click on the 'Exit' button to discard the changes made and return to the User/Group window.

Group Name	<input type="checkbox"/>
group1	<input type="checkbox"/>

User Name	<input type="text"/>
Password	<input type="text"/>
Confirm Password	<input type="text"/>

Step 2: Here the user can choose to configure this user account to belong to a group or not. Select the appropriate Group Name by ticking the check box.

Click on the 'Back' button to return to the previous window.
Click on the 'Next' button to accept the change and continue to the next window.

Click on the 'Exit' button to discard the changes made and return to the User/Group window.

Step 3: Here the user can configure the appropriate Network Access settings for the user by simply ticking one of the following options. Read Only, Read Write or Deny Access.

Click on the 'Back' button to return to the previous window.
Click on the 'Next' button to accept the change and continue to the next window.
Click on the 'Exit' button to discard the changes made and return to the User/Group window.

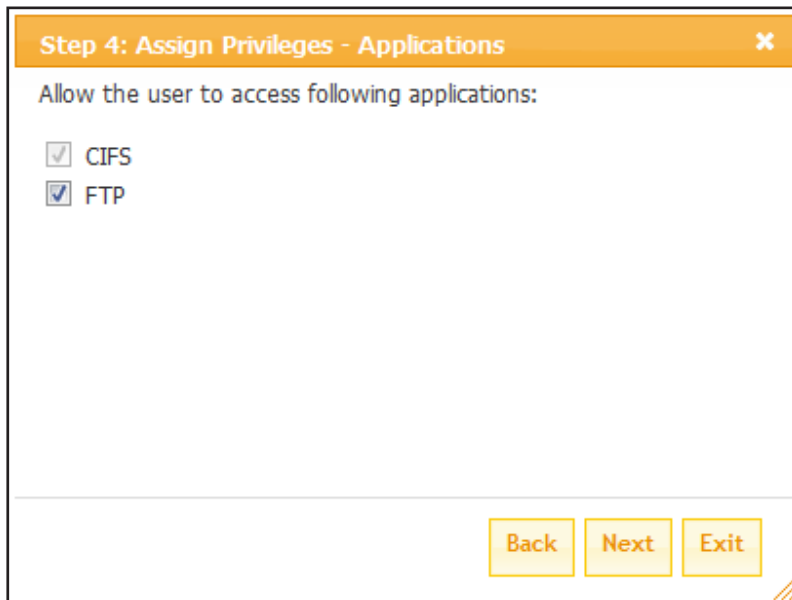

Step 4: Assign Privileges - Applications

Allow the user to access following applications:

CIFS

FTP

Back Next Exit

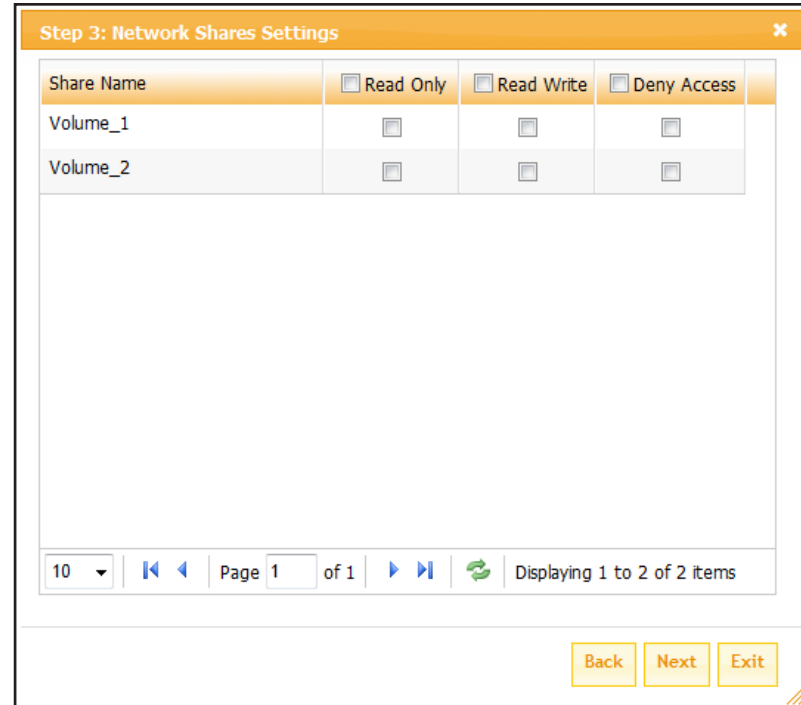

Share Name	<input type="checkbox"/> Read Only	<input type="checkbox"/> Read Write	<input type="checkbox"/> Deny Access
Volume_1	<input type="checkbox"/>	<input type="checkbox"/>	<input type="checkbox"/>
Volume_2	<input type="checkbox"/>	<input type="checkbox"/>	<input type="checkbox"/>

10 Page 1 of 1 Displaying 1 to 2 of 2 items

Back Next Exit

Step 4: Here the user can configure the application privileges assigned to this user. Option to select are CIFS or FTP. CIFS is short for Common Internet File System and FTP is short for File Transfer Protocol.

Click on the 'Back' button to return to the previous window.
Click on the 'Next' button to accept the change and continue to the next window.
Click on the 'Exit' button to discard the changes made and return to the User/Group window.

Step 5: Here the user can configure the Quotas settings for the user account. Enter the quota amount in the block indicated in Megabytes. By entering 0MB the quota will be set to unlimited.

Click on the 'Back' button to return to the previous window.
Click on the 'Next' button to accept the change and continue to the next window.
Click on the 'Exit' button to discard the changes made and return to the User/Group window.

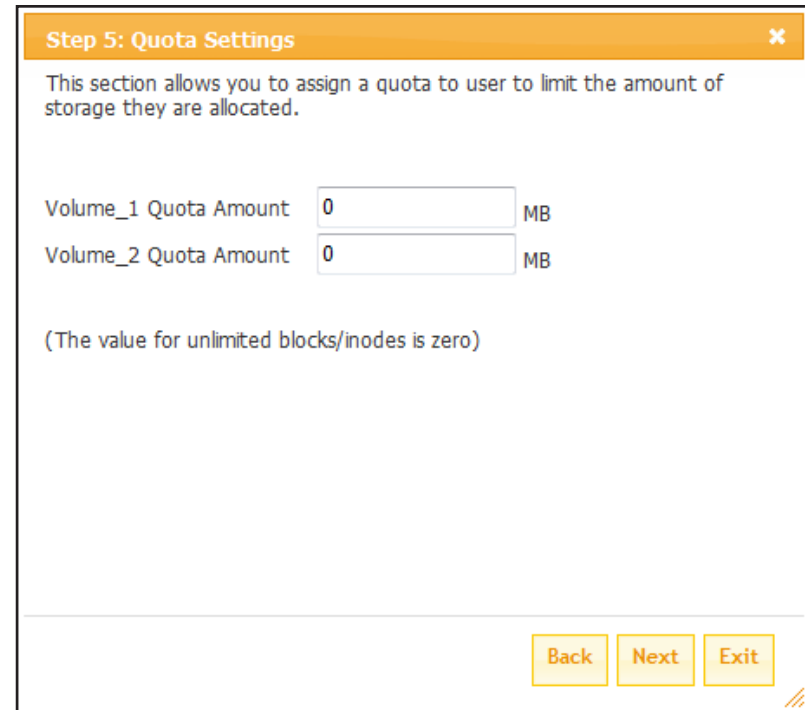
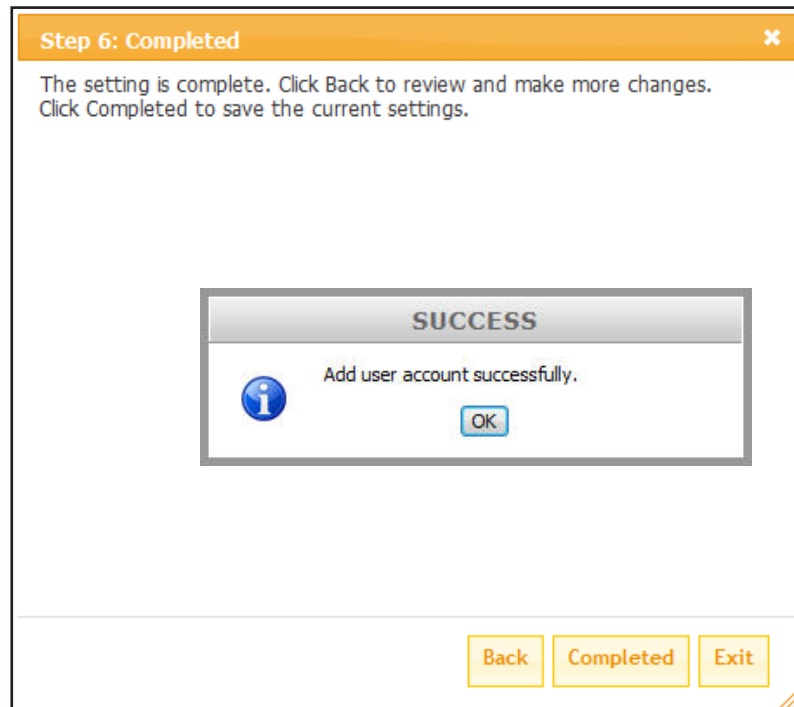

Step 6: Here the user can confirm to create the new account.

Click on the 'Back' button to return to the previous window.
Click on the 'Completed' button to accept the change and complete the wizard.
Click on the 'Exit' button to discard the changes made and return to the User/Group window.

After the new account has been created, a window will appear that states the account was created successfully. Click on the 'OK' button to continue.

Adding New Groups

The following section will describe how to add a new group on this device. To add a group click on the 'Add' button. A easy to configure wizard will be launched and look like the following:

Start: This window welcomes the user to the setup wizard for adding or modifying a group. This wizard will guide the user through the steps of setup.

In this wizard the user will be able to:

- 1) Create a new group.
- 2) Join the user to a group.
- 3) Configure the appropriate network shares settings.
- 4) Configure the quota settings.
- 5) View a summary of the configuration before completing the addition.

Click on the 'Next' button to continue.

Click on the 'Exit' button to discard the changes made and return to the User/Group window.

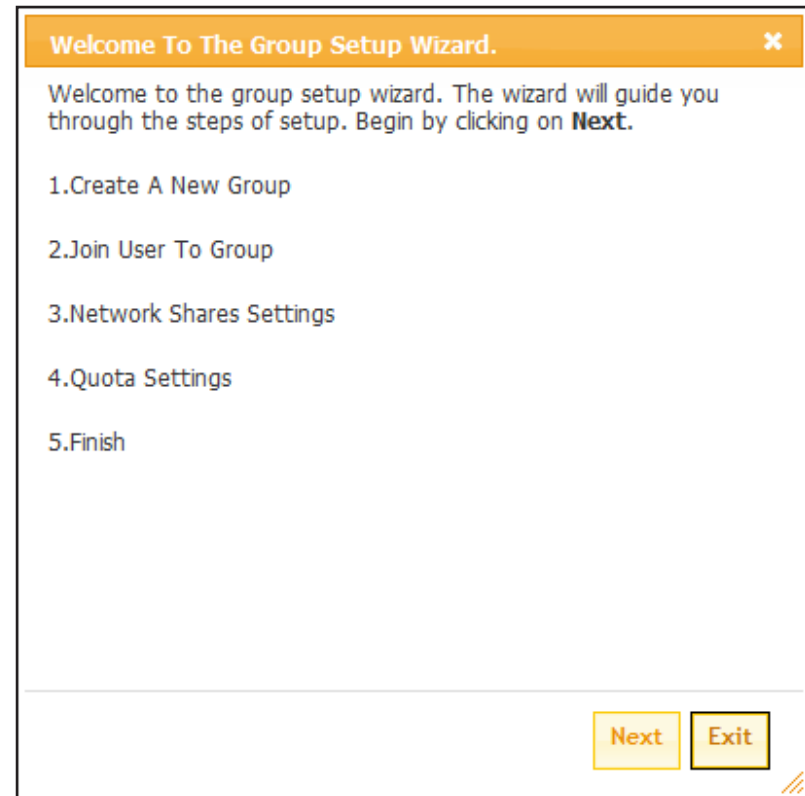

Step 1: Here the user can enter the Group Name for the new group being created.

Click on the 'Back' button to return to the previous window.
Click on the 'Next' button to accept the change and continue to the next window.
Click on the 'Exit' button to discard the changes made and return to the User/Group window.

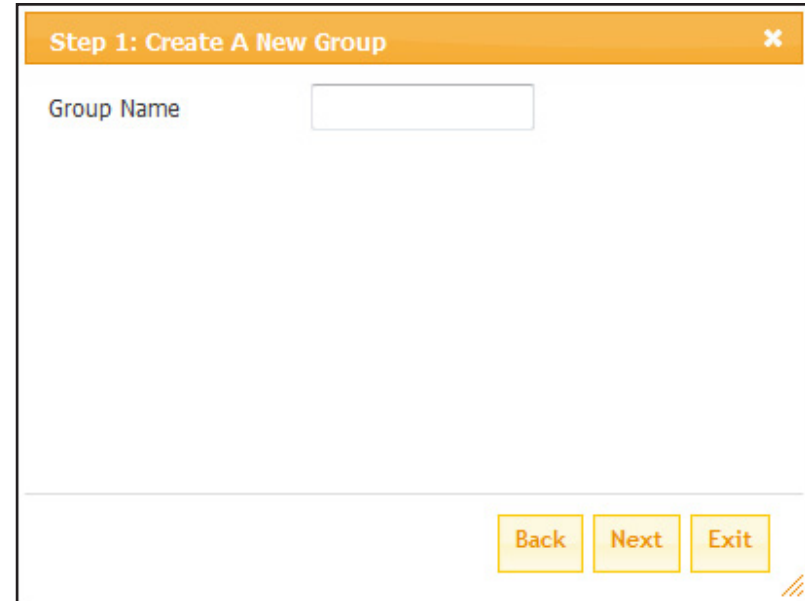

The screenshot shows a dialog box titled "Step 1: Create A New Group" with a close button (X) in the top right corner. Below the title bar, there is a label "Group Name" followed by an empty text input field. At the bottom right of the dialog, there are three yellow buttons labeled "Back", "Next", and "Exit".



The screenshot shows a dialog box titled "Step 2: Join User To Group" with a close button (X) in the top right corner. The main area contains a table with a header "User Name" and a single row with the value "user1". To the right of the "user1" row is a small square checkbox. At the bottom right of the dialog, there are three yellow buttons labeled "Back", "Next", and "Exit".

User Name	
user1	<input type="checkbox"/>

Step 2: Here the user can choose to configure a user account to belong to this group or not. Select the appropriate user by ticking the check box next to it.

Click on the 'Back' button to return to the previous window.
Click on the 'Next' button to accept the change and continue to the next window.
Click on the 'Exit' button to discard the changes made and return to the User/Group window.

Step 3: Here the user can configure the appropriate Network Access settings for this group by simply ticking one of the following options. Read Only, Read Write or Deny Access.

Click on the 'Back' button to return to the previous window.
Click on the 'Next' button to accept the change and continue to the next window.
Click on the 'Exit' button to discard the changes made and return to the User/Group window.

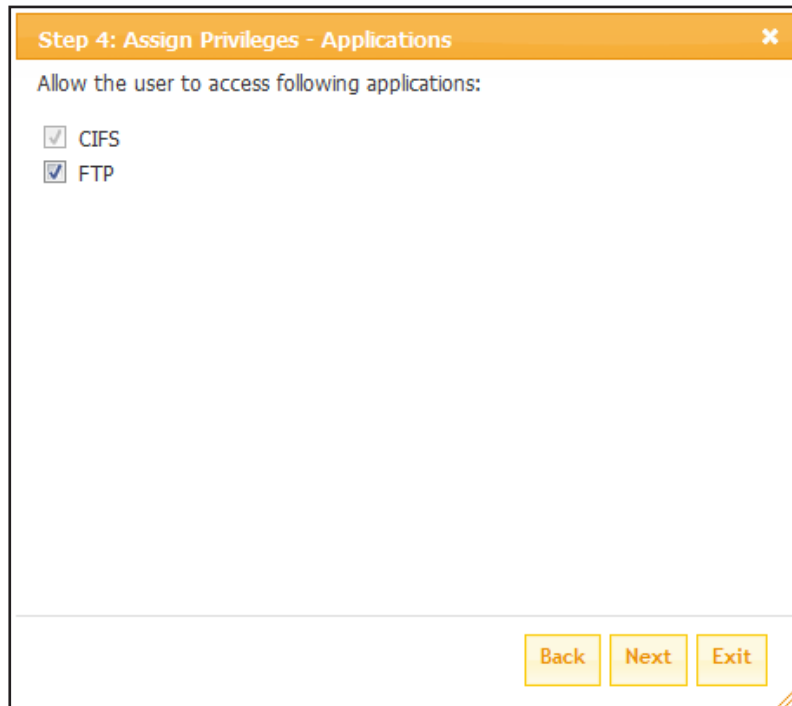

Step 4: Assign Privileges - Applications

Allow the user to access following applications:

- CIFS
- FTP

Back Next Exit

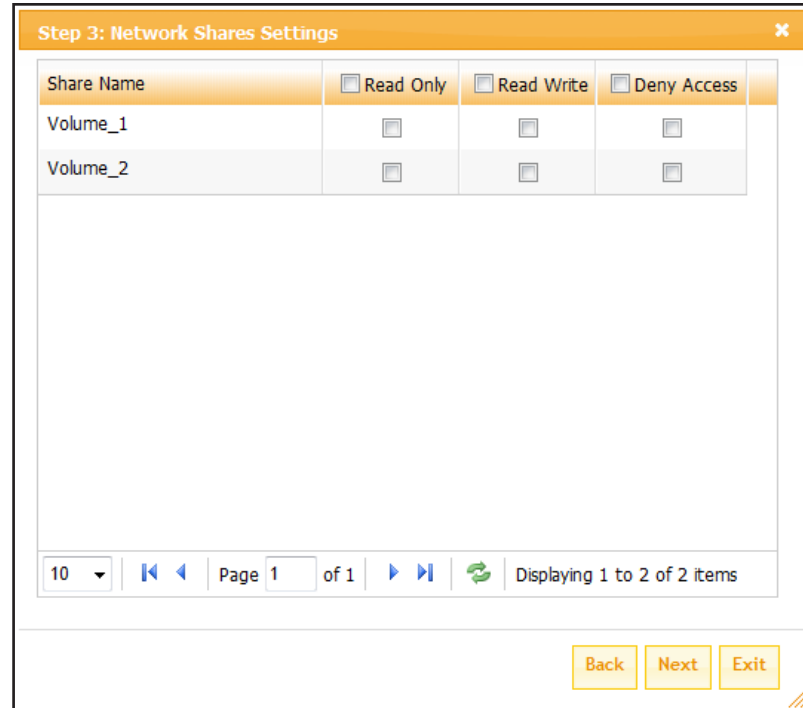

Share Name	<input type="checkbox"/> Read Only	<input type="checkbox"/> Read Write	<input type="checkbox"/> Deny Access
Volume_1	<input type="checkbox"/>	<input type="checkbox"/>	<input type="checkbox"/>
Volume_2	<input type="checkbox"/>	<input type="checkbox"/>	<input type="checkbox"/>

10 Page 1 of 1 Displaying 1 to 2 of 2 items

Back Next Exit

Step 4: Here the user can configure the application privileges assigned to this group. Option to select are CIFS or FTP. CIFS is short for Common Internet File System and FTP is short for File Transfer Protocol.

Click on the 'Back' button to return to the previous window.
Click on the 'Next' button to accept the change and continue to the next window.
Click on the 'Exit' button to discard the changes made and return to the User/Group window.

Step 5: Here the user can configure the Quotas settings for this group. Enter the quota amount in the block indicated in Megabytes. By entering 0MB the quota will be set to unlimited.

Click on the 'Back' button to return to the previous window.
Click on the 'Next' button to accept the change and continue to the next window.
Click on the 'Exit' button to discard the changes made and return to the User/Group window.

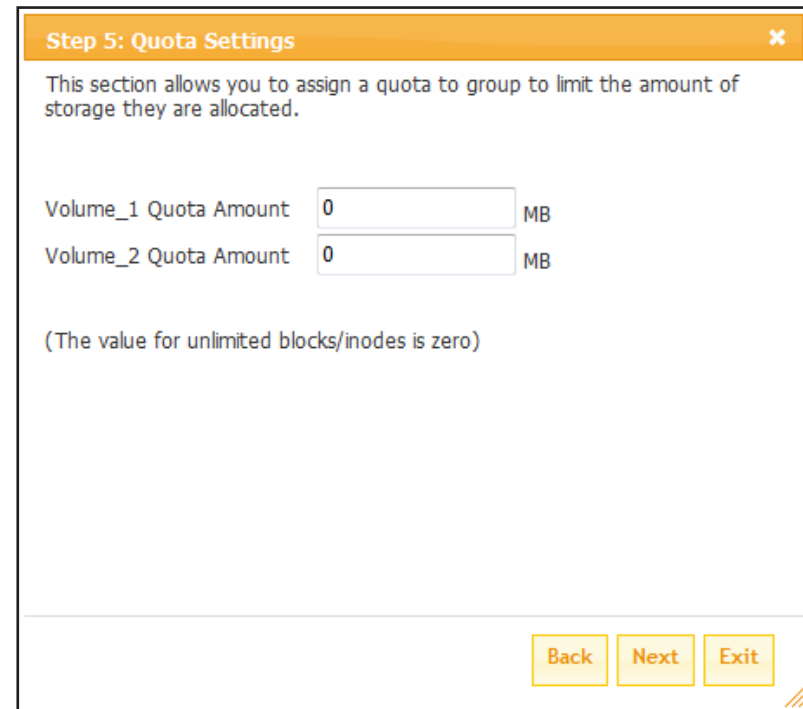
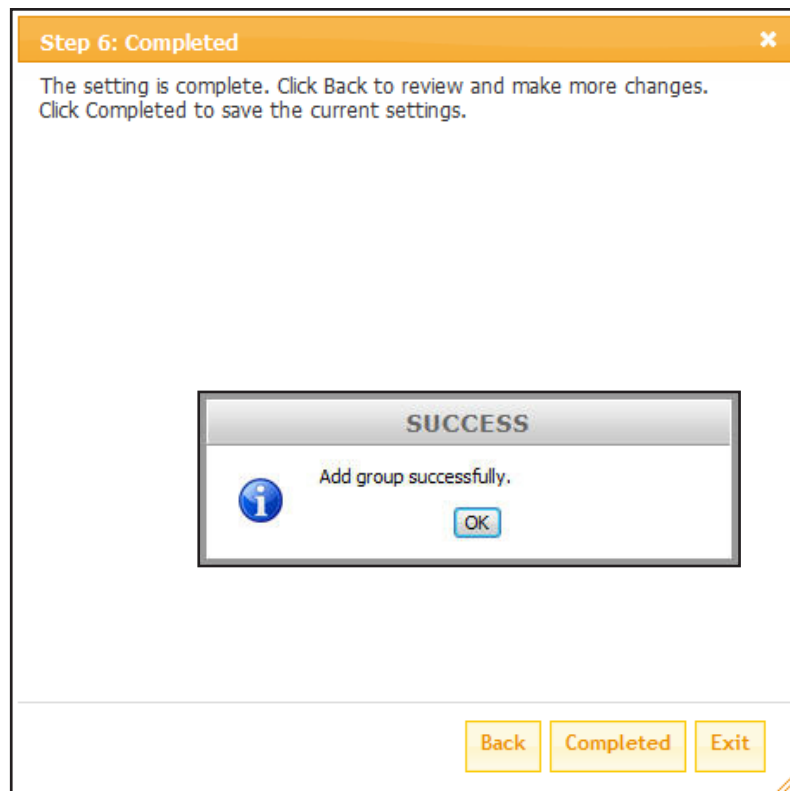

Step 6: Here the user can confirm to create the new group.

Click on the 'Back' button to return to the previous window.
Click on the 'Completed' button to accept the change and completed the wizard.
Click on the 'Exit' button to discard the changes made and return to the User/Group window.

After the new group has been created, a window will appear that states the group was created successfully. Click on the 'OK' button to continue.

Network Shares Page

The Network Shares page allows the user to configure shared folders and rights to specific users and groups. To be able to create new network access rules, the default rule must first be removed by simply selecting it and clicking on the 'Delete' button.

Network Shares: The Network Shares Settings window allows the user to add, modify and remove new and existing network share rules.

To add a rule click on the 'Add' button. To modify an existing rule click on the 'Modify' button. To remove a rule click on the 'Delete' button.

To select a rule, simply click on the rule and the entry should change to a red color that indicates it's selected for use.



At the bottom the user can navigate through pages and also refresh the window by clicking on the 'Refresh' button.





Lastly, if at any point the user wants to reset the network access list to the default configuration, click on the 'Reset Network Access List' button.

NETWORK SHARES SETTINGS :

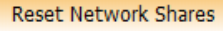

The Network Shares page allows the user to configure shared folders and rights to specific users and groups.

NETWORK SHARES SETTINGS :

Share Name	Path	CIFS	FTP	NFS
Volume_1	Volume_1			-
Volume_2	Volume_2			-



10  Page 1 of 1   Displaying 1 to 2 of 2 items

Adding New Network Shares

The following section will describe how to add a new network share on this device. To add a network share click on the 'Add' button. A easy to configure wizard will be launched and look like the following:

Start: This window welcomes the user to the setup wizard for adding or modifying a network share. This wizard will guide the user through the steps of setup.

In this wizard the user will be able to:

- 1) Select share folders.
- 2) Configure shared folder access rights.
- 3) Configure network access settings.
- 4) View a summary of the configuration before completing.

Click on the 'Next' button to continue.

Click on the 'Exit' button to discard the changes made and return to the Network Shares Page.

Step 1: Here the user can select the appropriate folder to include in this network share by ticking the respective folder.

Click on the 'Back' button to return to the previous window.

Click on the 'Next' button to accept the change and continue to the next window.

Click on the 'Exit' button to discard the changes made and return to the Network Shares Page.

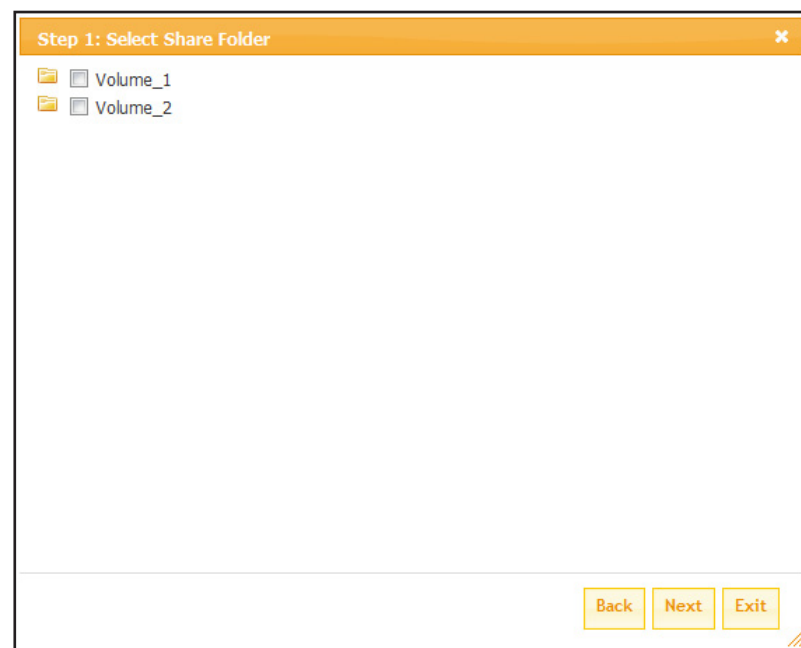
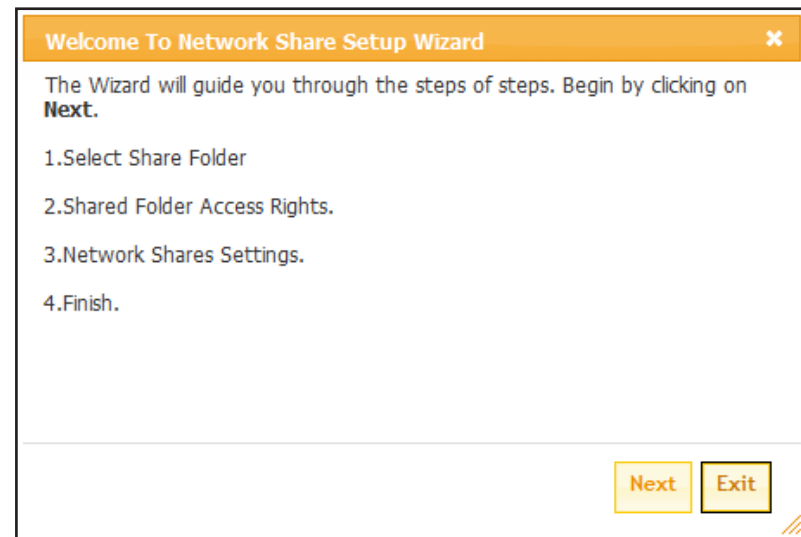

Step 2: Here the user can choose which user accounts or group are allowed to access this folder(s). Select 'All account' to allow access to this folder to all the accounts. Select 'Specific User/group' to only allow certain users or groups access to this folder.

Click on the 'Back' button to return to the previous window.

Click on the 'Next' button to accept the change and continue to the next window.

Click on the 'Exit' button to discard the changes made and return to the Network Shares Page.

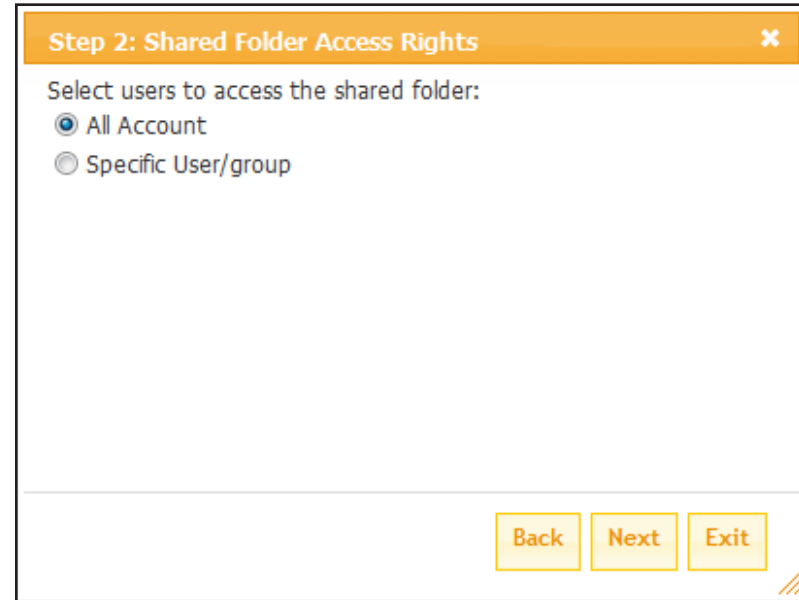

Step 2-1: Here the user can select the appropriate access rights for the share. Options to choose from are 'Read Only', 'Read Write' and 'Deny Access'. So yes, this procedure can also be used to block certain users from accessing certain folders.

Click on the 'Back' button to return to the previous window.

Click on the 'Next' button to accept the change and continue to the next window.

Click on the 'Exit' button to discard the changes made and return to the Network Shares Page.



Step 3: Here the user can assign privileges to this share. Opportunistic locks (oplocks) are a characteristic of the LAN Manager networking protocol implemented in the 32bit Windows family. Oplocks are guarantees made by a server for a shared logical volume to its clients. These guarantees inform the Client that a file's content will not be allowed to be changed by the server, or if some change is imminent, the client will be notified before the change is allowed to proceed. Oplocks are designed to increase network performance when it comes to network file sharing. However it is recommended to set the share oplocks to No (off) when using file-based database applications. When enabled, the file attribute "Map Archive" will be copied as the file is being stored on the ShareCenter Pulse. Certain backup software attach this attribute to files that are being stored as backups.

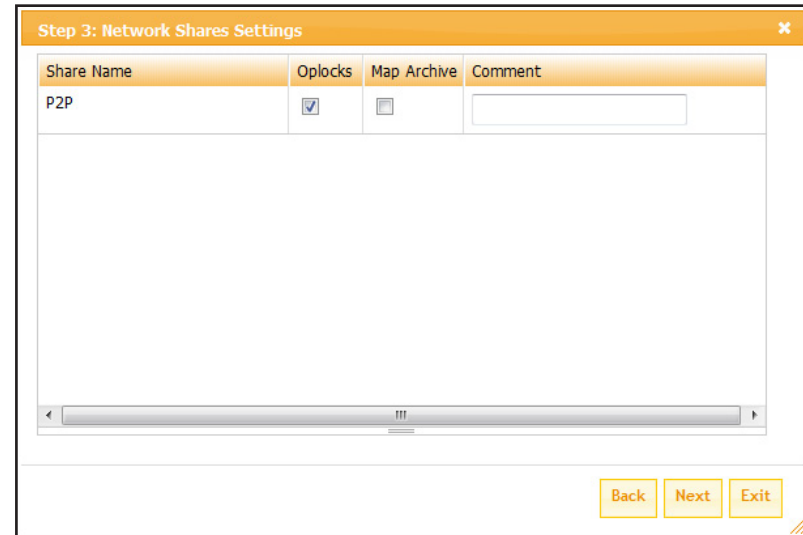

Click on the 'Back' button to return to the previous window. Click on the 'Next' button to accept the change and continue to the next window. Click on the 'Exit' button to discard the changes made and return to the Network Shares Page.

Step 3-1: Here the user can assign more privileges to that user can use in this share. Options to choose from are CIFS, AFP, FTP and NFS. CIFS is short for Common Internet File System. AFP is short for Apple Filing Protocol. FTP is short for File Transfer Protocol. NFS is short for Network File System.

Click on the 'Back' button to return to the previous window.
Click on the 'Next' button to accept the change and continue to the next window.
Click on the 'Exit' button to discard the changes made and return to the Network Shares Page.

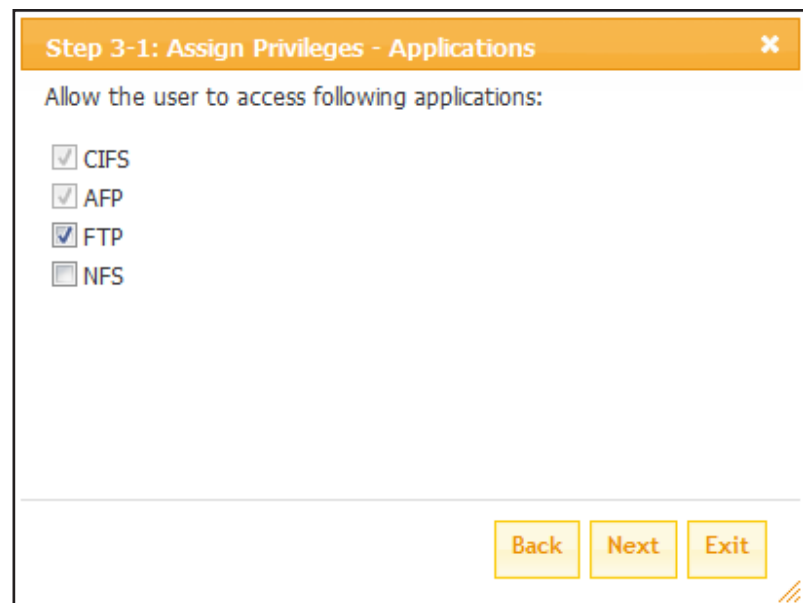

Step 3-2: Here the user can configure the FTP settings for this share. FTP access can be:

- 1) FTP Anonymous None (No Access).
- 2) FTP Anonymous Read Only (Limited Access).
- 3) FTP Anonymous Read/Write (Full Access).

Click on the 'Back' button to return to the previous window.
 Click on the 'Next' button to accept the change and continue to the next window.
 Click on the 'Exit' button to discard the changes made and return to the Network Shares Page.



Step 4: Here the user view a summary of the share created.

Click on the 'Back' button to return to the previous window.
 Click on the 'Completed' button to accept the change and complete the wizard.
 Click on the 'Exit' button to discard the changes made and return to the Network Shares Page.

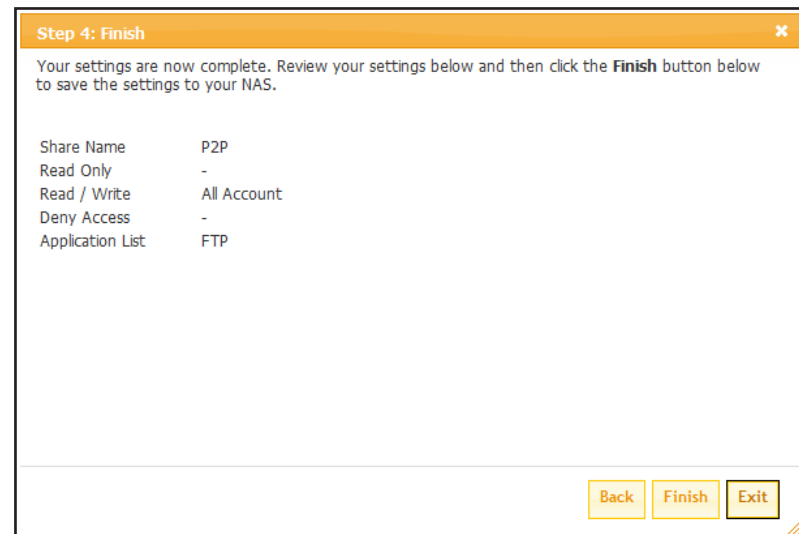

Quotas Page

The ShareCenter Pulse supports storage quotas for both groups and individual users. Assigning a quota to a group or user will limit the amount of storage they are allocated. By default, users and groups do not have a quota.

Quota Settings: Here the user can enable the quota settings option. Once the quota settings have been enabled the Status will change to started.

User Quota Settings: In this window all the users with their respective quotas will be displayed. Here the user can quickly and easily change the quota for each individual user by simply clicking on the parameter listed in the Limit column, shown here as 'Unlimited'.

After selecting the limit column parameter, the user will be able to configure the quota for the respective user.

To accept the new quota settings simply click anywhere in this windows outside the parameter field. This new quota will be displayed, like in this example 1000Mb.

QUOTA SETTINGS :

This section allows you to assign a quota to a group or user to limit the amount of storage they are allocated. By default, users and groups do not have a quota.

QUOTA SETTINGS :

Status : Stopped

USER QUOTA SETTINGS :

No.	User Name	Volume_1	
		Used	Limit
1	user1	0 MB	Unlimited

Page: 1 Page: 1/1, Total Records: 1

USER QUOTA SETTINGS :

No.	User Name	Volume_1	
		Used	Limit
1	user1	0 MB	<input type="text" value="0"/>

Page: 1 Page: 1/1, Total Records: 1

USER QUOTA SETTINGS :

No.	User Name	Volume_1	
		Used	Limit
1	user1	0 MB	1000 MB

Page: 1 Page: 1/1, Total Records: 1

Group Quota Settings:

In this window all the groups with their respective quotas will be displayed. Here the user can quickly and easily change the quota for each individual group by simply clicking on the parameter listed in the Limit column, shown here as 'Unlimited'.

After selecting the limit column parameter, the user will be able to configure the quota for the respective group.

To accept the new quota settings simply click anywhere in this windows outside the parameter field. This new quota will be displayed, like in this example 1000Mb.

GROUP QUOTA SETTINGS :

No.	Group Name	Volume_1	
		Used	Limit
1	group1	0 MB	Unlimited

Page: 1 << < > >> Page: 1/1, Total Records: 1

GROUP QUOTA SETTINGS :

No.	Group Name	Volume_1	
		Used	Limit
1	group1	0 MB	<input type="text" value="0"/>

Page: 1 << < > >> Page: 1/1, Total Records: 1

GROUP QUOTA SETTINGS :

No.	Group Name	Volume_1	
		Used	Limit
1	group1	0 MB	1000 MB

Page: 1 << < > >> Page: 1/1, Total Records: 1

FTP Server Page

The ShareCenter Pulse is equipped with a built in FTP Server. The server is easy to configure and allows users access to important data whether they are on the local network or at a remote location. The FTP server can be configured to allow user access to specific directories, and will allow up to 10 users to access the ShareCenter Pulse simultaneously.

Max. User: Set the maximum amount of users that can connect to the FTP server.

Idle Time: Set the amount of time a user can remain idle before being disconnected.

Port: Set the FTP port. Default is 21.

Passive Mode: In situations where the device is behind a firewall and unable to accept incoming TCP connections, passive mode must be used.

Client Language: Most standard FTP clients like Windows FTP, only support Western European code page when transferring files. Support has been added for non standard FTP clients that are capable of supporting these character sets.

Flow Control: Allow you to limit the amount of bandwidth available for each user.

SSL/TLS: Here the user can enable the SSL/TLS connection only.

FTP SERVER SETTINGS :

Assign permissions for users and groups who will be accessing the FTP server from over the Internet.

This section contains the configuration settings for the built in FTP server. The server is easy to configure and allows up to 10 users to access the server locally or remotely at the same time.

FTP SERVER SETTINGS :

Max UserMax. User	<input type="text" value="10"/>
Idle Time	<input type="text" value="10"/> (1~10 Minutes)
Port	<input type="text" value="21"/> (1025 to 3688, 3690 to 49999, 65501 to 65535, Default: 21)
Passive Mode	<input checked="" type="radio"/> Use the default port range(55536-55663) <input type="radio"/> Use the following port range: <input type="text" value="55536"/> ~ <input type="text" value="55663"/> <input type="checkbox"/> Report external IP in PASV mode External IP : <input type="text"/> . <input type="text"/> . <input type="text"/> . <input type="text"/>
Client Language	<input type="text" value="Western European"/>
Flow Control	<input checked="" type="radio"/> Unlimited <input type="radio"/> <input type="text"/> x 10 KBs
SSL/TLS	<input type="checkbox"/> Allow SSL/TLS connection only
<input type="button" value="Apply"/> <input type="button" value="Cancel"/>	



Please Note:

In order to use FXP (File Exchange Protocol) for server-to-server data transfer, please make sure to change the port from 21 to some other port as listed in the Port section of the web UI. Also, please make sure to open the corresponding port on your router and forward that port from your router to the ShareCenter Pulse.

FTP Server Status: Here you can Start or Stop the FTP Server.

If you are behind a router, you will need to forward the FTP port from the router to the ShareCenter Pulse. Additional filtering and firewall settings may need to be modified on your router to allow FTP Access to the ShareCenter Pulse from the Internet. Once the port has been forwarded on the router, users from the internet will access the FTP server through the WAN IP address of the router.

FTP SERVER STATUS :	
Status	Stopped
Port	21
Max Users	10
Flow Control	Unlimited
Idle Time	10
Client Language	Western European
SSL/TLS connection	No
Passive Mode	55536~55663

Start FTP Server

FTP Access Behind a Router

If you are behind a router, you will need to forward the FTP port from the router to the ShareCenter Pulse. Additional filtering and firewall settings may need to be modified on your router to allow FTP Access to the ShareCenter Pulse from the Internet. Once the port has been forwarded on the router, users from the internet will access the FTP server through the WAN IP address of the router.

If you are using a D-Link router, such as the WBR-2310 used in the example below, your port forwarding rule should be similar to the following:

- Name:** Type a name for the ShareCenter Pulse FTP server rule.
- IP Address:** Enter the IP address of the ShareCenter Pulse.
- Public Port:** Enter the public FTP port. By default, the port is 21.
- Private Port:** Enter the private FTP port. By default, the port is 21.
- Traffic Type:** Set the traffic type to TCP.

D-Link

WBR-2310 // SETUP ADVANCED TOOLS STATUS SUPPORT

VIRTUAL SERVER RULES :

The Virtual Server option allows you to define a single public port on your router for redirection to an internal LAN IP Address and Private LAN port if required. This feature is useful for hosting online services such as FTP or Web Servers.

Save Settings Don't Save Settings

20 - VIRTUAL SERVER RULES

	Name	IP Address	Port	Traffic Type	Schedule
<input checked="" type="checkbox"/>	DNS-343_FTP	192.168.0.32	Public 21	TCP	Always
<input type="checkbox"/>			Public	TCP	Always

Helpful Hints...

- Check the **Application Name** drop down menu for a list of pre-defined applications that you can select from. If you select one of the pre-defined applications, click the arrow button next to the drop down menu to fill out the appropriate fields.
- You can select your computer from the list of DHCP clients in the **Computer Name** drop down menu, or enter the IP address manually of the computer you would like to open the specified port to.
- In order to apply a schedule to a Virtual Server Rule, you must first define a schedule on the **Tools -> Schedules** page.

If you use an FTP port other than 21, then users accessing the FTP server using an FTP client will have to specify the non-standard port, and users who are using a browser will have to specify the port in the URL (e.g. ftp://ftp.dns346.com:3000, where the FTP port is 3000).

FTP over TLS

Below we'll examine FTP over over TLS. For this example we'll use FireFTP. FireFTP is an open-source, cross platform FTP client for Mozilla Firefox users who want to use FTP or FTPS.

- Step 1:** From the Tools menu click **FireFTP** to open the application in Mozilla Firefox.
- Step 2:** Go to the **Quick Connect** drop down menu and choose **Create an Account**.

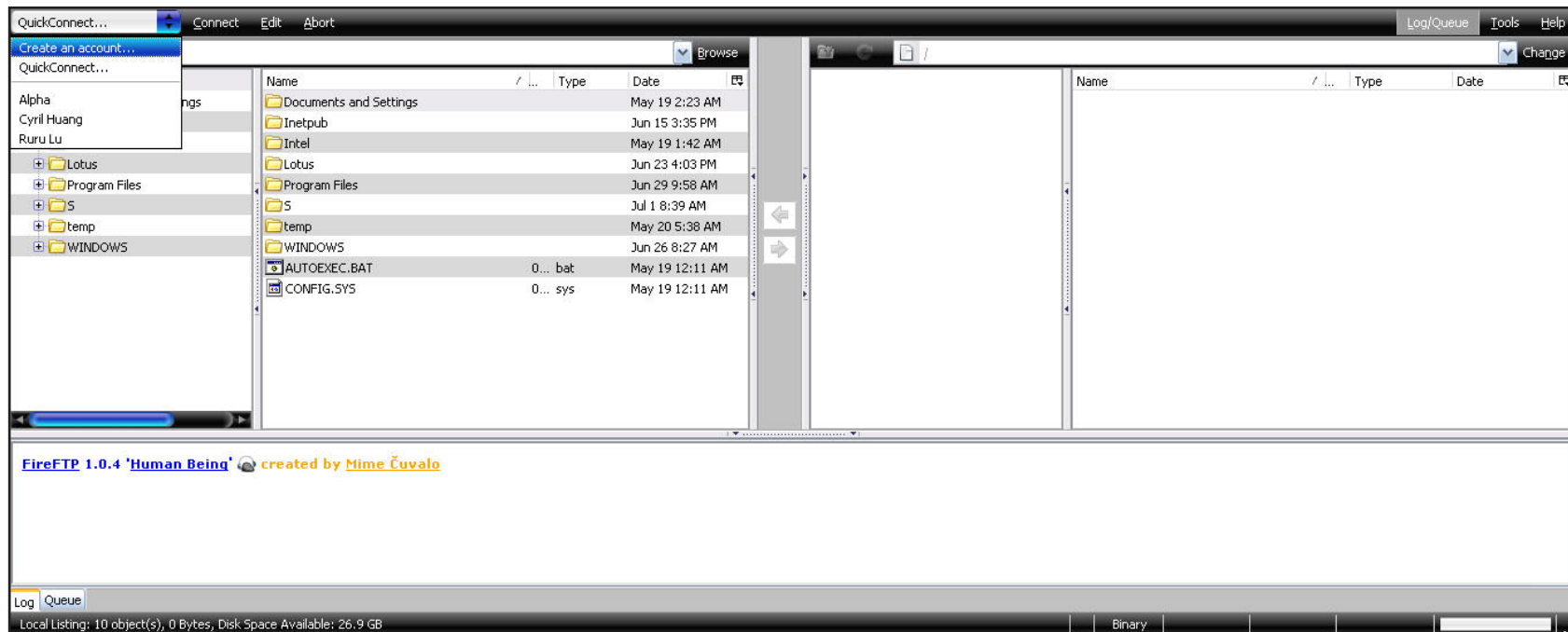
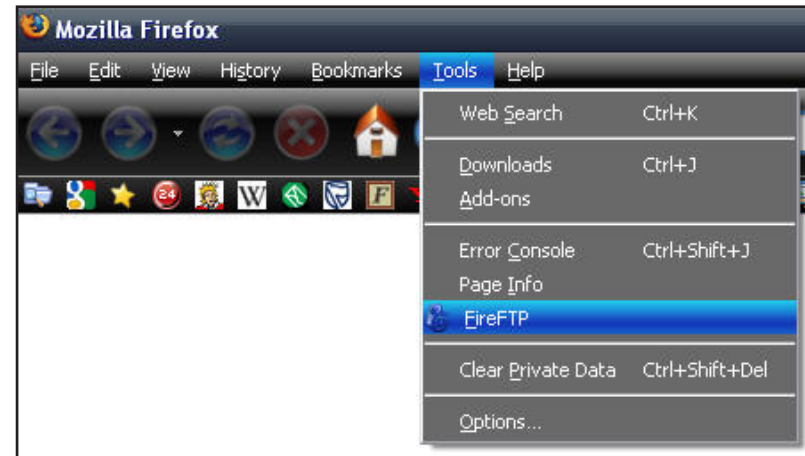

Step 3: Account Name:

Enter a name for this FTP connection here.

Host:

Enter the IP of the ShareCenter Pulse in here.

Login:

Enter the user's username in here.

Password:

Enter the user's password in here.

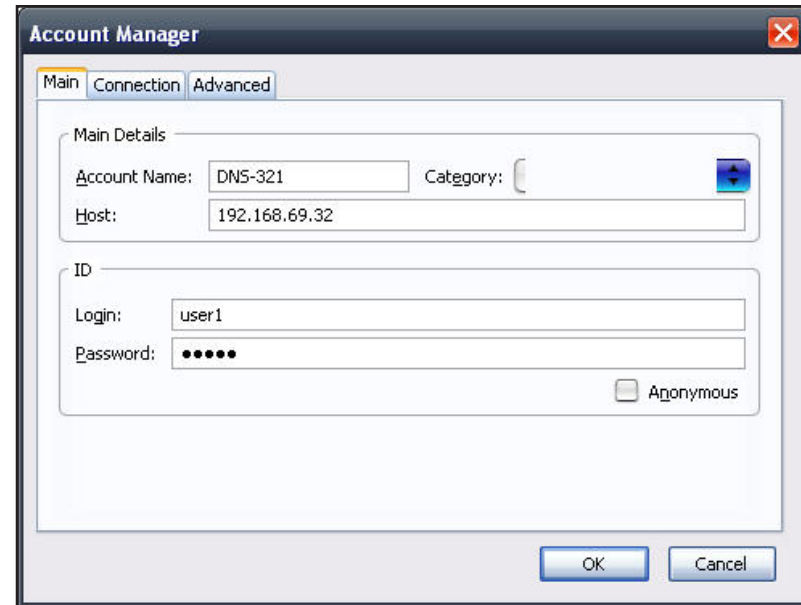

Step 4: Go to the **Connection** Tab and set the **Security** function to '**Auth TLS (Best)**'.

Then press **OK** to finish the setup.

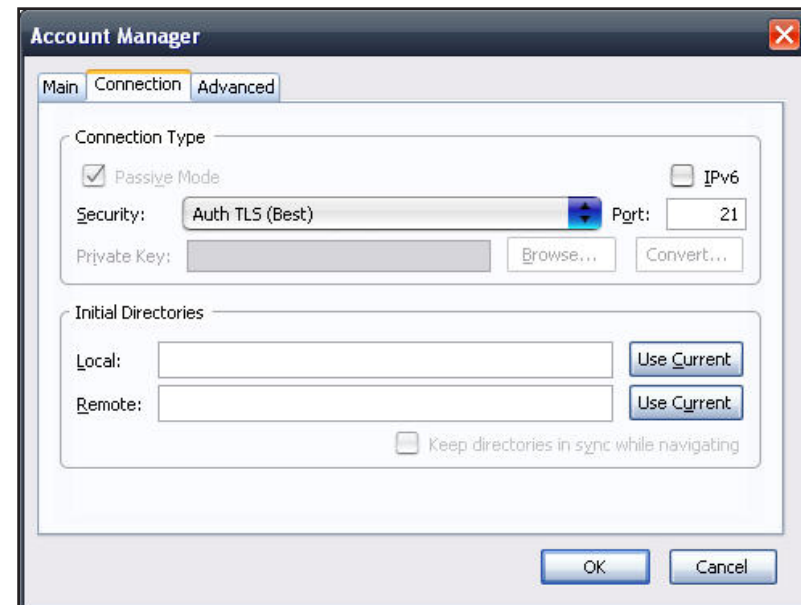

Step 5: Firefox and FireFTP will now start a series of security confirmations.

The first warning should look like this.

Click on the “**Or you can add an exception...**” button to accept the security change.



Step 6: The second warning should look like this.

Click on the “**Add exception...**” button to accept the security change.



Step 7: The next step is to get the certificate for the connection. Click on the “**Get Certificate**” button to acquire the certificate.



Step 8: After the certificate has been acquired click on the **“Confirm Security Exception”** button to finish the security confirmations.

Step 9: Select the newly added FTP connection and click on the **Connect** option if it has not already connected by itself.

If you can see your files on the right block from the ShareCenter Pulse, the connection has been established successfully.

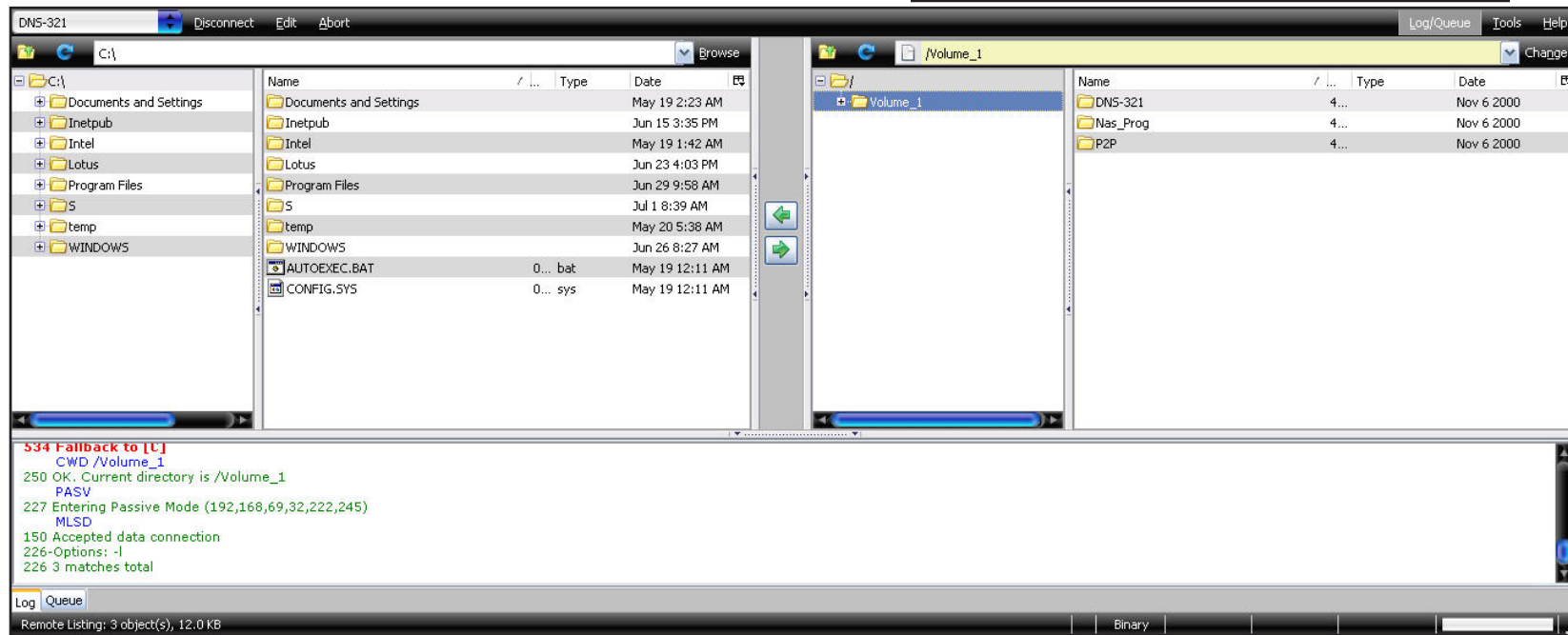

UPnP AV Server Page

The ShareCenter Pulse features a UPnP AV Server. This server provides the ability to stream photos, music and videos to UPnP AV compatible network media players. If the server is enabled, the ShareCenter Pulse will be automatically detected by UPnP AV compatible media players on your local network.

Click the 'Refresh All' button to update all the shared files and folder lists.

UPnP AV Server: Select Enable or Disable to enable or disable the ShareCenter Pulse UPnP AV server.

After enabling the UPnP AV Server option, the following window will appear.

In the window the user will be able to add, delete and view existing UPnP AV Server shared folders.

Add, Delete: To add a new folder to the shared list, click on the 'Add' button. To delete an existing folder, click on the 'Delete' button. To refresh the list, click on the 'Refresh' button.

Refresh: The 'Refresh' button allows the user to update the files and folders of a selected share.

UPnP AV SERVER SETTINGS :

This section allows you to configure the UPnP AV server. You can enable or disable the UPnP AV service, and specify the folder or directory that will be shared.

The DNS-320 will automatically scan for file updates when content is added or deleted from the available folders. You can also click the "Refresh All" button to manually scan for file updates.

UPnP AV SERVER SETTINGS :

UPnP AV Server Enable Disable

NO.	Shared Folder	State
1	Volume_1/P2P	✔

of 1

 Displaying 1 to 1 of 1 items

UPnP AV SERVER REFRESHING:

Refreshed Successfully.

Add: After click the 'Add' button, the user will be able to select certain folder that will be included in the UPnP AV Server folder list.

Select the appropriate folder and click on the 'Save Settings' button to add the folders.

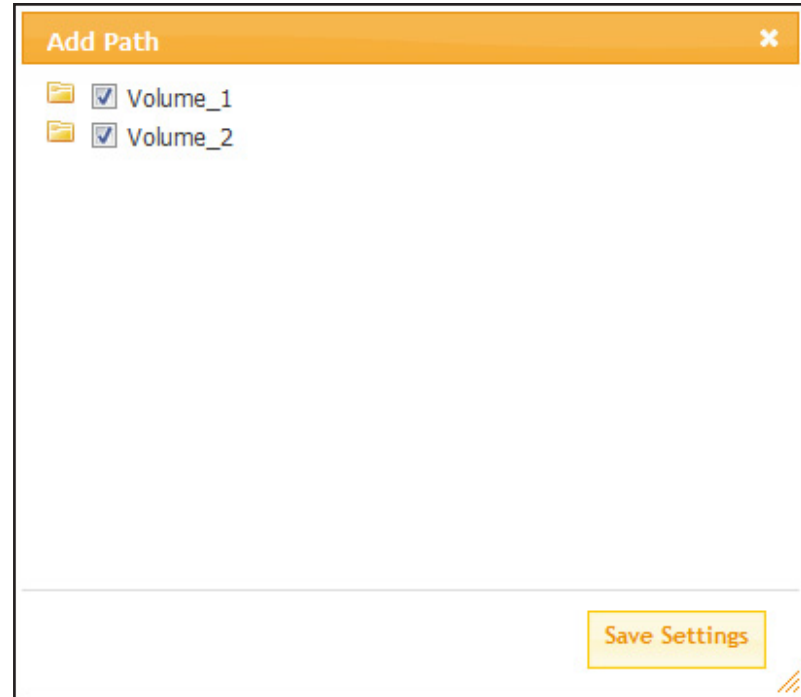

iTunes Server Page

The ShareCenter Pulse features an iTunes Server. This server provides the ability to share music and videos to computers on the local network running iTunes. If the server is enabled, the ShareCenter Pulse will be automatically detected by the iTunes program and the music and videos contained in the specified directory will be available to stream over the network. Click the 'Refresh' button to manually update the shared files and folders.

iTunes Server: Select to enable or disable the iTunes Server.

Folder: Specifies the folder or directory that will be shared by the iTunes server. Select root to share all files on all volumes, or click Browse to select a specific folder.

Password: Sets password for the iTunes server. (Optional)

MP3 Tag Codepage: Here the user can select the MP3 Tag Codepage used by this device. Currently the Codepage is set to Western European.

Auto Refresh: Here the user can select the Automatically Refresh time.

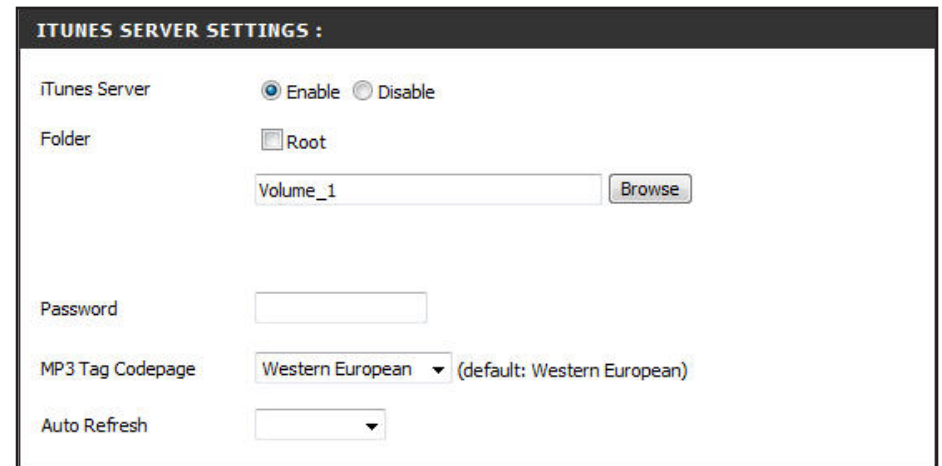
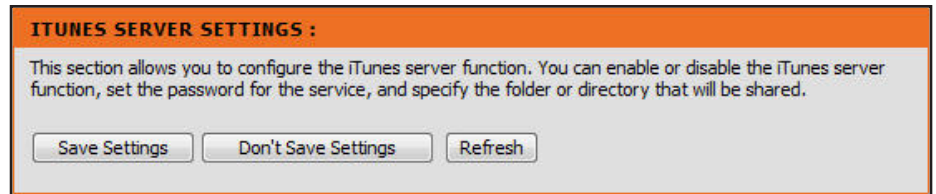

After enabling the iTunes server on the ShareCenter Pulse, launch iTunes. In your iTunes utility, select the ShareCenter Pulse and enter the iTunes server password if required.

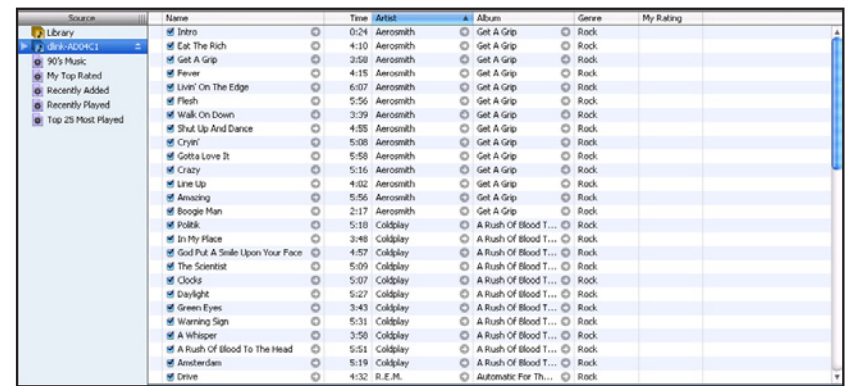
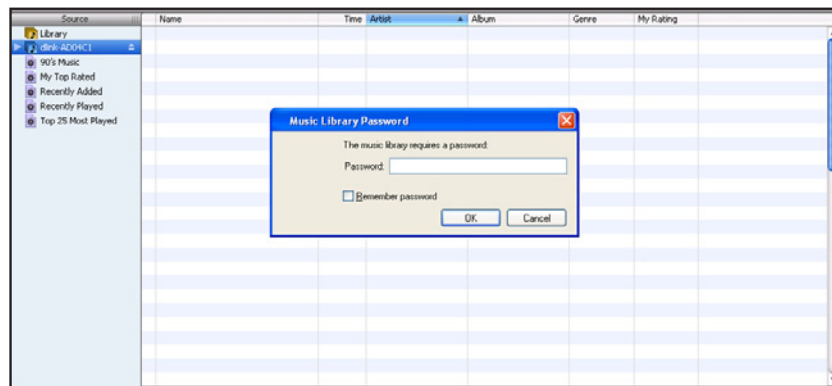

Select the ShareCenter Pulse. When prompted, enter in the iTunes server password. Click OK.

Media stored on the ShareCenter Pulse will then be available for use in iTunes.

Time Machine Page

This section allows the user to configure the ShareCenter Pulse so that it becomes a backup destination in the Mac OS X Time Machine. In order to use this function, the AFP service is required. The AFP service will start automatically as soon as this function is enabled.

Time Machine Settings:

Here the user can enable the Time Machine option.

After enabling the Time Machine option the following window will appear. In this window the user can add, delete and view Time Machine entries.

To add an entry, click on the 'Add' button.

To delete an entry, click on the 'Delete' button.

To remove all the Time Machine entries, click on the 'Remove All Network Shares' button.

To add NAS folders as a destination for the OS X Time Machine backup, carry out the following:

1. Check the Enable Time Machine box.
2. Click the 'New' button.
3. Check the boxes next to the NAS folders that you want to use as OS X Time Machine destinations.
4. Click the Next button.
5. If you want to edit the name that will be used to identify the NAS folders in the OS X Time Machine, click the Share Name that you want to modify and make the required name change.
6. When you have finished configuring the Time Machine settings, click the Completed button.

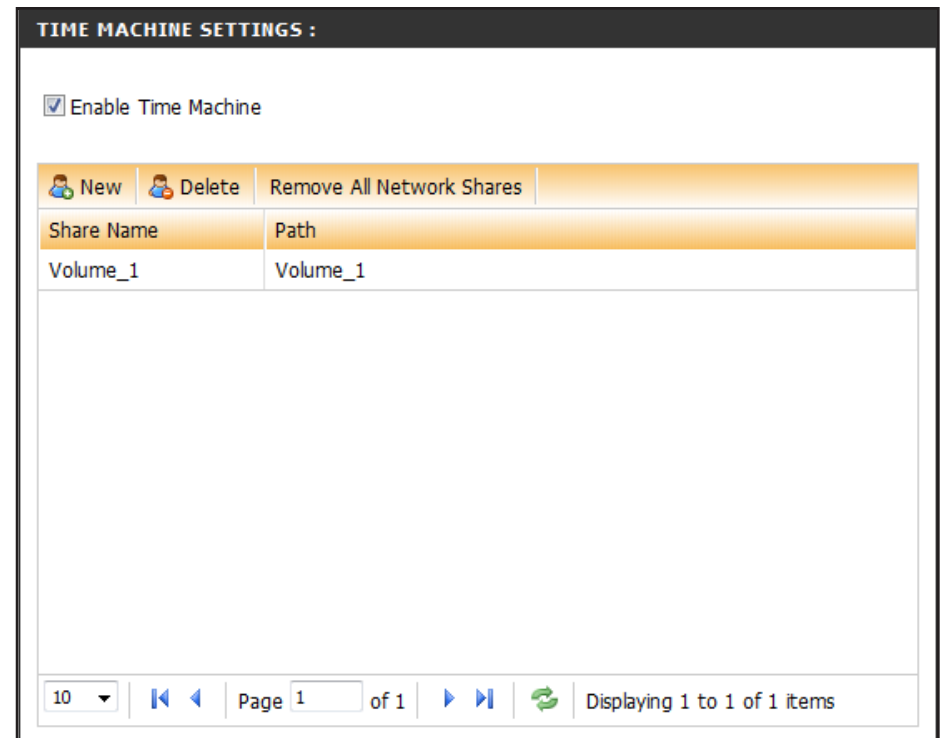
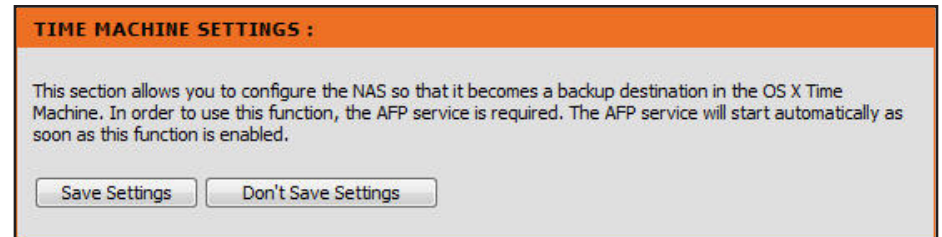

In this window the user can select the path listed here and click on the 'Next' button to continue.

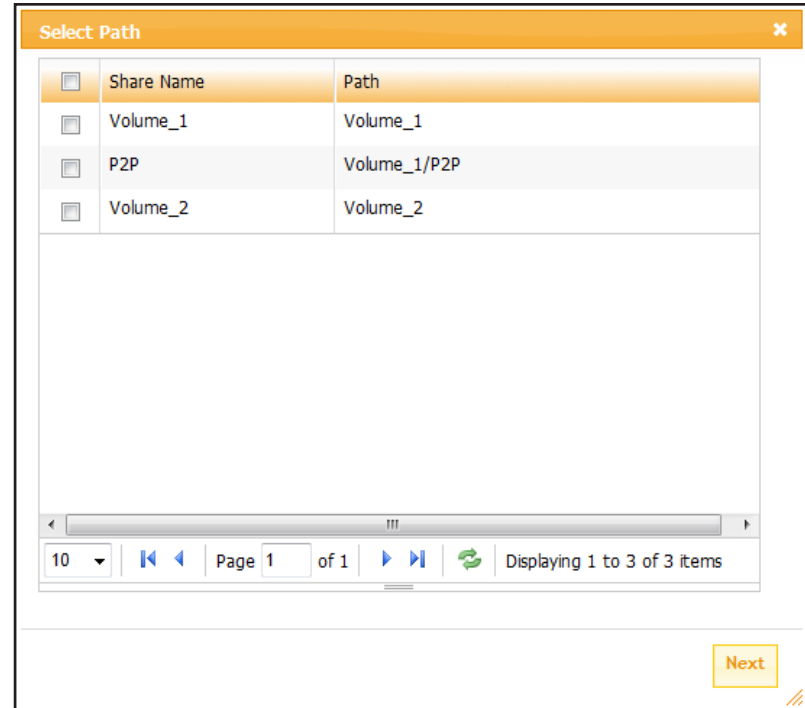
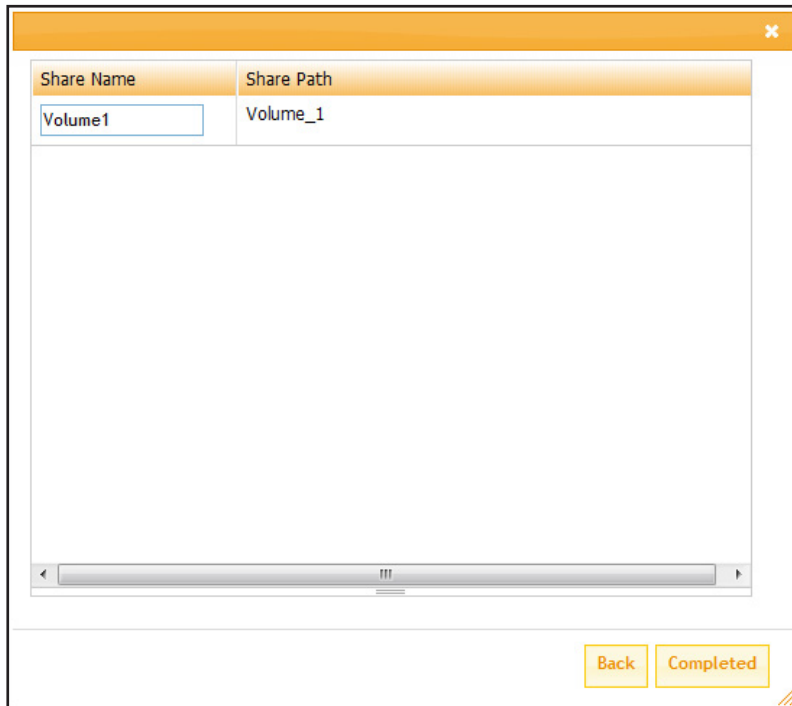

In this window the user can view the path selected and click on the 'Completed' button to complete the wizard. Alternatively the user can click on the 'Back' button to re-configure the path.

On this page the user can enable the Apple Filing Protocol service option. If the Time Machine option is used, this option should be enabled automatically.

AFP Service : Here the user can enable the AFP Service option. Enabling this service will disable the oplocks option.

Click on the 'Apply' button to accept the change.

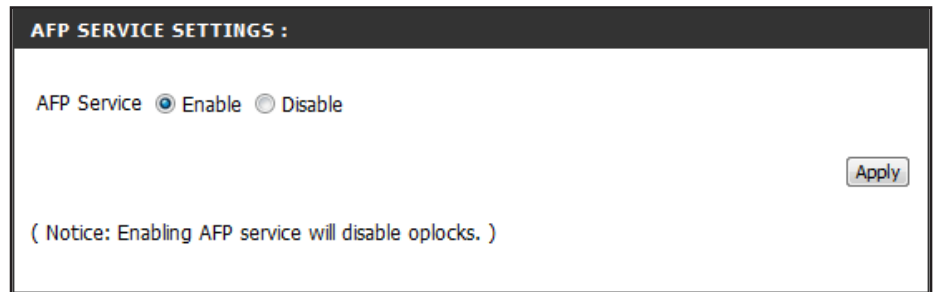
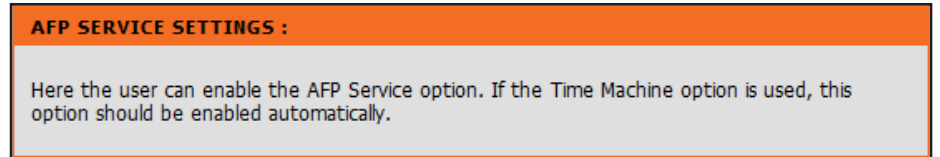

NFS Service Page

Here the user can enable the NFS Service option.

NFS Service : Here the user can enable the NFS Service option.

Click on the 'Apply' button to accept the change.

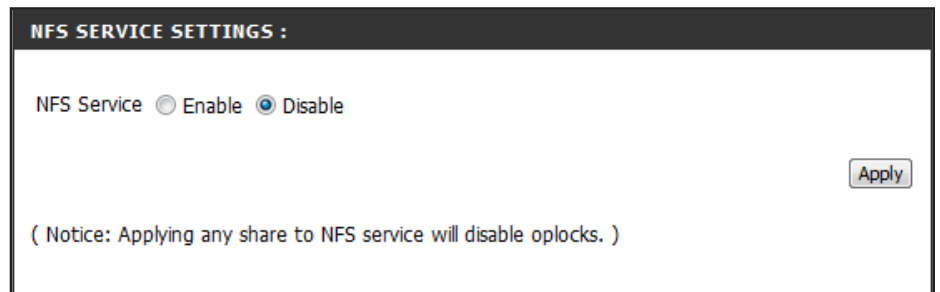
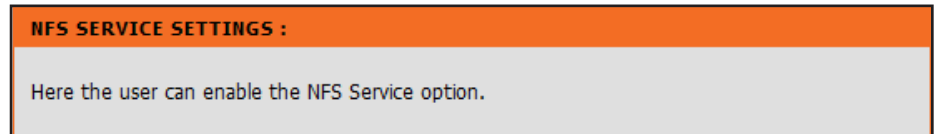

Maintenance Section

Admin Password: This section allows you to set a password for your admin account. By default there is no password configured. It is highly recommended that you set an admin password in order to keep your system secure.

System: The System Settings section allows you to restart the system, shutdown the system, or restore the device to the factory default setting. Restoring the unit to factory settings will erase all settings, including any rules that you have created.

Firmware Upgrade: A new firmware update may be available for your ShareCenter Pulse. It is recommended that you keep your ShareCenter Pulse firmware up-to-date in order to maintain and improve the functionality and performance of your system.

E-mail Alerts: This section allows you to configure e-mails to be sent to you when certain operational and drive status conditions are present. These alerts can prove helpful in managing and safeguarding important data.

Power Management: This section allows you to enable or disable the Hibernation function.

RAID: This section allows you to setup a RAID configuration on the selected hard drives. Please note that the data stored on the drives will be erased during the formatting process.

Dynamic DNS: The Dynamic DNS feature allows you to host a server using a domain name that you have purchased with your dynamically assigned IP address.

Disk Diagnostic: This section allows you to perform a health test on your hard drives. In addition, you can set a schedule for your tests and receive email notifications.

The screenshot displays the D-Link web interface for a DNS-320 device. The top navigation bar includes 'D-Link' and tabs for 'SETUP', 'ADVANCED', 'MAINTENANCE', 'STATUS', and 'SUPPORT'. The 'MAINTENANCE' tab is active, showing a sidebar menu with options like 'Admin Password', 'System', 'Firmware Upgrade', 'E-mail Alerts', 'Power Management', 'RAID', 'Dynamic DNS', 'Disk Diagnostic', and 'Logout'. The main content area is titled 'ADMINISTRATOR SETTINGS :'. It contains a message: 'This section allows you to set a password for your admin account. By default there is no password configured. It is highly recommended that you set an admin password in order to keep your system secure.' Below this message are two buttons: 'Save Settings' and 'Don't Save Settings'. A second 'ADMINISTRATOR SETTINGS :' section contains input fields for 'User Name' (pre-filled with 'admin'), 'Password', 'New Password', and 'Confirm Password'. On the right side, there is a 'Helpful Hints.' section with text: 'For security reasons, it is recommended that you change the Password for the Administrator. Be sure to write down the new Password to avoid having to reset the DNS-320 in the event that it is are forgotten.' The bottom of the page features a 'STORAGE' section.

Admin Password Page

The Admin menu allows you to set a password for the admin account. It is recommended to set an admin account password when first configuring the ShareCenter Pulse.

Username: The administrator user name is admin, and this cannot be changed.

Password: Enter the current password. (Leave this blank if you have not set a password yet.)

New Password: Enter a new password.

Confirm Password: Enter the new password again for confirmation.

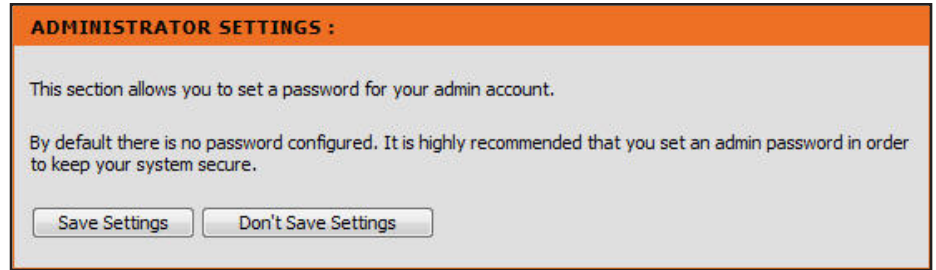

ADMINISTRATOR SETTINGS :

This section allows you to set a password for your admin account.

By default there is no password configured. It is highly recommended that you set an admin password in order to keep your system secure.



ADMINISTRATOR SETTINGS :

User Name	<input type="text" value="admin"/>
Password	<input type="text"/>
New Password	<input type="text"/>
Confirm Password	<input type="text"/>

System Page

The ShareCenter Pulse System menu provides options for system restarts, saving and loading configuration settings, and idle times setting.

Restart: Click on the 'Restart' button to reboot the device.

Default: Click on the 'Restore' button to reset the device to its factory default settings. This will erase all previous configuration changes.

Shutdown: Click on the 'Shutdown' button to turn off the device. This will help to prevent data loss.

Configuration Settings: Click on the 'Save' button to save the current configuration settings to a file on the local computer. If at a later time you need to reload this configuration after a system reset, browse the file and click Load.

SYSTEM SETTINGS :

The System Settings section allows you to restart the system, shutdown the system, or restore the device to the factory default setting. Restoring the unit to factory settings will erase all settings, including any rules that you have created.

The current system settings can be saved as a file onto the local hard drive. The saved file can be uploaded into the unit.

RESTART :

System Restart.

DEFAULT :

Restore To Factory Default Settings.

SHUTDOWN :

System Shutdown.

CONFIGURATION SETTINGS :

Save Configuration Settings.

Load Configuration Settings.

Idle Time: Enter the time (in minutes) that the administrator will be allowed to remain idle while accessing the device configuration utility that users will be allowed to remain idle while accessing the download schedule settings.

System Temperature Threshold: Here the user can configure the system temperature threshold value. This value can be set in Fahrenheit or Celsius.

IDLE TIME :

Account Inactivity Timer (Minutes)

SYSTEM TEMPERATURE THRESHOLD :

System Temperature Threshold °F

Firmware Upgrade Page

The Firmware Upgrade Page makes it simple to check for new firmware releases and upload them to the device. This section provides a link to check for new firmware on the D-Link support website. If a new firmware is available, download the file to your local computer.

FIRMWARE UPGRADE :

A new firmware upgrade may be available for your DNS-320. It is recommended to keep your DNS-320 firmware up-to-date to maintain and improve the functionality and performance of your storage device.

Click [D-Link Support Page](#) to check for the latest available firmware.

To upgrade the firmware on your DNS-320, please download and save the latest firmware version from the [D-Link Support Page](#) to your local hard drive. Locate the file on your local hard drive by clicking the Browse button. Once you have found and opened the file using the browse button, click the Apply button to start the firmware upgrade.

CURRENT FIRMWARE INFORMATION :

Current NAS Firmware Version : 1.00

Firmware Date : 08/13/2010

Firmware Path :

- Firmware Version:** The current firmware version is displayed here.
- Firmware Date:** The current firmware version date is displayed here.
- Firmware Upgrade:** When upgrading the firmware, click Browse to select the new firmware file on your local computer. Click Apply to begin the firmware upgrade process.

E-mail Alerts Page

With the ShareCenter Pulse E-Mail Alerts, you can configure e-mails to be sent alerting you to certain operational conditions and drive status conditions. These alerts can prove helpful with the management and safeguarding of important data.

Login Method: Select either Account or Anonymous. Choosing Anonymous does not require a User Name or Password.

Username: Enter the appropriate user name for your e-mail account.

Password: Enter the appropriate password for your e-mail account.

Port: Enter the SMTP port number used here.

SMTP Server: Enter the IP address or domain name of your outgoing mail server. If you are unsure of this value, contact your e-mail provider.

Sender E-Mail: Enter the "from" e-mail address (e.g. alerts@share.com). This field does not require a valid e-mail address. However, if your e-mail client is filtering spam, make sure you allow this address to be received.

Receiver E-Mail: Enter the e-mail address you want to send the alerts to.

SMTP Authentication: This address must correspond with the SMTP server configured above.

Test E-Mail: Tick this option to use SMTP authentication.

Click the Test E-Mail button to send a test alert and confirm your settings are correct.

Login Method: Choosing Anonymous does not require a User Name or Password.

Port: Enter the SMTP port number used here.

SMTP Server: Enter the IP address or domain name of your outgoing mail server. If you are unsure of this value, contact your e-mail provider.

Sender E-mail: Enter the "from" e-mail address (e.g. alerts@share.com). This field does not require a valid e-mail address. However, if your e-mail client is filtering spam, make sure you allow this address to be received.

Receiver E-Mail: Enter the e-mail address you want to send the alerts to. This address must correspond with the SMTP server configured above.

E-MAIL ALERTS :

This section allows you to configure e-mails to be sent to you when certain operational and drive status conditions are present. These alerts can prove helpful in managing and safeguarding important data.

E-MAIL SETTINGS :

Login Method Account Anonymous

User Name

Password

Port

SMTP Server

Sender E-mail

Receiver E-mail

SMTP Authentication

E-MAIL SETTINGS :

Login Method Account Anonymous

Port

SMTP Server

Sender E-mail

Receiver E-mail

Alert Types: Select the information you want e-mailed to the above address. The space status can be sent in intervals, while the other items will only be sent when necessary.

ALERT TYPES :

- The Administrator Password Has Been Changed
- Space Status
 - Daily Time: 00 : 00
- One Of The Volumes Is Full
- Volume/Disk Status Has Been Changed
 - A Disk Has Been Removed
 - A Disk Has Been Inserted
 - A Volume Has Crashed
 - A Volume Has Been Rebuilt
 - A Volume Has Degraded
 - A Volume Is Rebuilding
- System Temperature Is Over User Defined Threshold
- Firmware Has Been Upgraded
- Send Log File
 - By Schedule
 - Daily Time: 00 : 00
 - When Log File Is Full
- One Torrent Download Is Finished
- Send S.M.A.R.T. Test Result
- System Has Rebooted From Power Failure

Power Management Page

The ShareCenter Pulse Power Management feature allows you to configure the drives to shut down while power remains constant to the device. The drives will power up again when data is accessed.

HDD Hibernation: Enable or Disable HDD Hibernation settings.
Turn Off Hard Drives: Set the amount of idle time before the drives will go into hibernation.

Power Recovery: Enable or disable Power Recovery. The Power Recovery feature will automatically restart your device from a previously unexpected shutdown due to a power failure.

Fan Control Type: The speed of the fan can be controlled from this section. If using “Auto” mode, the speed of the fan will change (Off/Low/High) depending on the internal temperature of the enclosure.

Power Off Scheduling: Here the user can configure the power off schedule. Enable or disable the power off schedule and configure the routine (Daily, Weekly or Monthly) and set the time.

POWER MANAGEMENT SETTINGS :

This section allows you to enable or disable the Hard Drive Hibernation and Power Recovery options. You can also configure cooling fan speeds using the Fan Control settings and you can set the schedule for the automatic Power Off function.

HARD DRIVE HIBERNATION SETTINGS :

HDD Hibernation : Enable Disable

Turn Off Hard Drives : ▼

POWER RECOVERY SETTINGS :

Power Recovery : Enable Disable

FAN CONTROL SETTINGS :

Type : ▼

POWER OFF SCHEDULING SETTINGS :

Power Off : Enable Disable

▼ Time: ▼ : ▼

RAID Page

The ShareCenter Pulse supports four different disk configuration types: Standard, where each drive is a unique volume, JBOD, which combines both drives in a linear fashion to create one volume, as well as RAID 0 and RAID 1.

RAID Configuration: Here the user can view the current RAID configuration and also (re-)configure the RAID setup.

Click on the 'Set RAID Type and Re-Format' button to change the current drive configuration. All data will be lost on your hard drives when changing the drive configuration.

To configure the remaining space into a new volume, click on the 'Create A New Volume From The Remaining Available Storage Space' button.

This section allows you to change the hard drive configuration or to format the newly inserted hard drive. Notice that the data stored in formatted drives will be erased during the process.

Physical Disk Info: In the section the user can view the physical hard disk information. Information displayed are:

- 1) Which slot is used.
- 2) The Hard Drive Vendor abbreviation.
- 3) The Hard Drive Model Code.
- 4) The Hard Drive Serial Number.
- 5) The Hard Drive Size.

HARD DRIVE CONFIGURATION :

This section allows you to setup a RAID configuration on the selected hard drives. Please note that the data stored on the drives will be erased during the formatting process.

AUTO-REBUILD CONFIGURATION allows you to enable or disable the Auto-Rebuild feature. You can also manually rebuild by clicking the "Manually Rebuild Now" button in the RAID CONFIGURATION section. Please note that rebuilding your volume will erase all data on the newly inserted drive.

RAID CONFIGURATION :

Current RAID Type

Volume_1 : RAID 1 (Completed)

Set RAID Type and Re-Format

Create A New Volume From The Remaining Available Storage Space

HARD DRIVE CONFIGURATION :

This section allows you to change the hard drive configuration or to format the newly inserted hard drive. Notice that the data stored in formatted drives will be erased during the process.

RAID CONFIGURATION :

Slot	Vendor	Model	Serial Number	Size
R	WDC	WD10EVVS-63M5B0	WD-WCAV52163551	1000 GB
L	WDC	WD5000AAKS-22YGA	WD-WCAS85512740	500 GB

Next

RAID Configuration - Standard

Standard: There are 4 types of RAID configuration to choose from, Standard, JBOD, RAID 0 and RAID 1. This section covers the Standard configuration.

Select A RAID Type: Standard configuration creates two separate volumes (or one volume if only one hard drive is present). Each hard drive is its own volume. Select the appropriate RAID type and click on the '**Next**' button.

Summary: The next window will display the volumes connected and prompts that the RAID configuration will commence.

When ready click on the '**Format**' button to initiate the RAID configuration. This process will involve initializing, formatting and configuration of the RAID chosen.

A warning message will be displayed before the procedure starts stating that hard drives will be formatted and if the user wishes to continue. Click '**OK**' to continue.

After the configuration has completed the user will be prompted to click on the '**Finish**' button.

RAID CONFIGURATION :

Select A RAID Type :

- Standard (Individual Disks)
- JBOD (Linear - Combines Both Disks)
- RAID 0 (Striping - Best Performance)
- RAID 1 (Mirroring - Keeps Data Safe)

RAID CONFIGURATION :

Volume	Type	File System	Type	Size
Volume_1	Standard	EXT 3	1000 GB	
Volume_2	Standard	EXT 3	500 GB	

MESSAGE

 You are about to re-format the hard drive(s). All data will be erased. Do you wish to continue?

RAID CONFIGURATION :

Volume Name	File System	Model
Volume_1	EXT3	Standard
Volume_2	EXT3	Standard

RAID Configuration - JBOD

JBOD: There are 4 types of RAID configuration to choose from, Standard, JBOD, RAID 0 and RAID 1. This section covers the JBOD configuration.

Select A RAID Type: JBOD combines both hard drives in a linear fashion which will create one large volume geared towards maximum available space. Click **'Next'**.

Summary: The next window will display the volumes connected and prompts that the RAID configuration will commence.

When ready click on the **'Format'** button to initiate the RAID configuration. This process will involve initializing, formatting and configuration of the RAID chosen.

A warning message will be displayed before the procedure starts stating that hard drives will be formatted and if the user wishes to continue. Click **'OK'** to continue.

After the configuration has completed the user will be prompted to click on the **'Finish'** button.

RAID CONFIGURATION :

Select A RAID Type :

Standard (Individual Disks)

JBOD (Linear - Combines Both Disks)

RAID 0 (Striping - Best Performance)

RAID 1 (Mirroring - Keeps Data Safe)

Back Next

RAID CONFIGURATION :

Volume Type	File System	Type	Size
Volume_1	JBOD	EXT 3	1491 GB

Back Format

MESSAGE

 You are about to re-format the hard drive(s). All data will be erased. Do you wish to continue?

OK Cancel

RAID CONFIGURATION :

Volume Name	File System	Model
Volume_1	EXT3	JBOD

Finish

RAID Configuration - RAID 0

RAID 0: There are 4 types of RAID configuration to choose from, Standard, JBOD, RAID 0 and RAID 1. This section covers the RAID 0 configuration.

Select A RAID Type: RAID 0 combines both hard drives in a striped fashion which will create one large volume geared towards maximum performance. Click **'Next'**.

RAID Size Settings: In this section the user can view the available capacity that RAID 0 can use on the hard drives installed.

Then the user can configure the desired capacity to be used for the RAID 0 configuration by entering the desired capacity amount in the block provided.

To utilize the remaining space, (if the two HDDs differ in capacity), the user can choose to use JBOD for the remaining space. Tick this option is needed. Click **'Next'**.

Summary: The next window will display the volumes connected and prompts that the RAID configuration will commence.

When ready click on the **'Format'** button to initiate the RAID configuration. This process will involve initializing, formatting and configuration of the RAID chosen.

A warning message will be displayed before the procedure starts stating that hard drives will be formatted and if the user wishes to continue. Click **'OK'** to continue.

After the configuration has completed the user will be prompted to click on the **'Finish'** button.

RAID CONFIGURATION :

Select A RAID Type :

Standard (Individual Disks)

JBOD (Linear - Combines Both Disks)

RAID 0 (Striping - Best Performance)

RAID 1 (Mirroring - Keeps Data Safe)

RAID CONFIGURATION :

Available capacity of Raid 0 volume: 995 GB

Enter the desired capacity of Raid 0 volume : 995 GB

The remaining space will become a JBOD (Linear) volume.
Remaining space : 502 GB

Configure the remaining disk space as JBOD.

0 GB 995 GB

RAID CONFIGURATION :

Volume	Type	File System	Type	Size
Volume_1	RAID 0	EXT 3		995 GB

MESSAGE

 You are about to re-format the hard drive(s). All data will be erased. Do you wish to continue?

RAID CONFIGURATION :

Volume Name	File System	Model
Volume_1	EXT3	RAID 0

RAID Configuration - RAID 1

RAID 1: There are 4 types of RAID configuration to choose from, Standard, JBOD, RAID 0 and RAID 1. This section covers the RAID 1 configuration.

Select A RAID Type: RAID 1 mirrors the hard drives for redundancy. If one hard drive fails, the other still has all of the data. Replace the failed hard drive and it will re-mirror, restoring maximum data protection. Click **'Next'**.

Auto-Rebuild Settings: Auto-Rebuild is a feature that will allow the ShareCenter Pulse to initiate the Rebuilding phase automatically. The Rebuilding phase will occur when one or more hard drives fail and is replaced by a new one. Click **'Next'**.

WARNING - This feature will automatically format the newly added drive. If this feature is NOT required, click disable.

RAID Size Settings: In this section the user can view the available capacity that RAID 1 can use on the hard drives installed.

Then the user can configure the desired capacity to be used for the RAID 1 configuration by entering the desired capacity amount in the block provided.

To utilize the remaining space, (if the two HDDs differ in capacity), the user can choose to use JBOD for the remaining space. Tick this option is needed. Click **'Next'**.

In this section a summary of the configuration will be displayed. When ready click on the **'Format'** button to initiate the RAID configuration. This process will involve initializing, formatting and configuration of the RAID chosen.

RAID CONFIGURATION :

Select A RAID Type :

Standard (Individual Disks)

JBOD (Linear - Combines Both Disks)

RAID 0 (Striping - Best Performance)

RAID 1 (Mirroring - Keeps Data Safe)

Back Next

RAID CONFIGURATION :

Enable Auto-Rebuild

Disable Auto-Rebuild

Back Next

RAID CONFIGURATION :

Available capacity of Raid 1 volume: 497 GB

Enter the desired capacity of Raid 1 volume : 497 GB

The remaining space will become a JBOD (Linear) volume.

Remaining space : 503 GB

Leaving the remaining disk space for future.

0 GB 497 GB

Back Next

RAID CONFIGURATION :

Volume	Type	File System	Type	Size
Volume_1	RAID 1	EXT 3		497 GB

Back Format

MESSAGE

 You are about to re-format the hard drive(s). All data will be erased. Do you wish to continue?

OK Cancel

A warning message will be displayed before the procedure starts stating that hard drives will be formatted and if the user wishes to continue. Click **'OK'** to continue.

After the configuration has completed the user will be prompted to click on the **'Finish'** button.

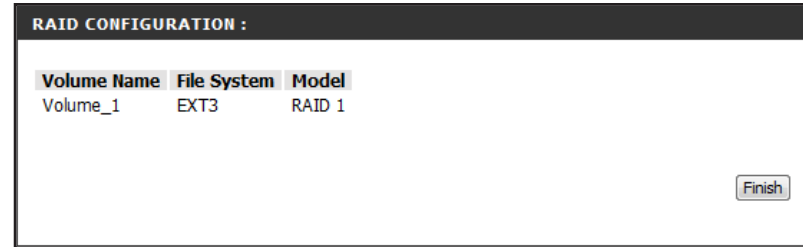

RAID CONFIGURATION :

Volume Name	File System	Model
Volume_1	EXT3	RAID 1

Finish

Auto-Rebuild Configuration:

Auto-Rebuild allows a degraded RAID 1 array to be automatically rebuilt when the failed hard drive is replaced by automatically restoring data from the existing hard drive to the newly inserted hard drive.



AUTO-REBUILD CONFIGURATION :

Enable Auto-Rebuild

Disable Auto-Rebuild

Manually Rebuild Now

Apply

Dynamic DNS Page

The DDNS feature allows the user to host a server (Web, FTP, Game Server, etc...) using a domain name that you have purchased (www.whateveryournameis.com) with your dynamically assigned IP address. Most broadband Internet Service Providers assign dynamic (changing) IP addresses. Using a DDNS service provider, your friends can enter your domain name to connect to your server regardless your IP address.

DDNS: Select Enable or Disable.

Server Address: Enter the DDNS server address or select from the drop-down menu.

Host Name: Enter your DDNS host name.

Username or Key: Enter your DDNS username or key.

Password or Key: Enter your DDNS password or key.

Verify Password: Re-enter your password or key.

Status: Displays your DDNS status.

When the user clicks on the 'Sign up for D-Link's Free DDNS service at www.DLinkDDNS.com' link, the user will be re-directed to the D-Link DDNS page.

Here the user can create or modify a D-Link DDNS account to use in this configuration.

DDNS SETTINGS :

The Dynamic DNS feature allows you to host a server (Web, FTP, Game Server, etc...) using a domain name that you have purchased (www.whateveryournameis.com) with your dynamically assigned IP address. Most broadband Internet Service Providers assign dynamic (changing) IP addresses. Using a DDNS service provider, your friends can enter your host name to connect to your NAS no matter what your IP address is.

[Sign up for D-Link's Free DDNS service at www.DLinkDDNS.com.](http://www.DLinkDDNS.com)

DDNS :

DDNS Enable Disable

Server Address << Select Dynamic DNS Server ▾

Host Name

Username or Key

Password or Key

Verify Password or Key

Status

D-Link

HOME UPGRADE ACCOUNT CHANGE EMAIL CHANGE PASSWORD SUPPORT

WELCOME TO SUPPORT SITE
DYNAMIC DNS
Call virtually anywhere in the world through a wireless network with a high-speed Internet connection...
[LEARN MORE](#)



HOW TO
FAQ
CONTACT
LOST PASSWORD

Existing Users
Log In Now...
User ID
Password
[Forgot Password](#)

New Users
Get Started!
[START](#)



Disk Diagnostic Page

S.M.A.R.T stands for “Self-Monitoring, Analysis, and Reporting Technology”. This is a system on a hard drive used to monitor and report on the health of the drive. If the HDD is grayed out, then it does not support S.M.A.R.T.

Scan Disk: Scan Disk will scan your system’s file system for errors and/or corruption. After completion, any errors on your file system will be displayed accordingly.

S.M.A.R.T Test: To run the S.M.A.R.T test, select the hard drive you wish to perform the S.M.A.R.T test on. Then select whether to run a Quick or Extended S.M.A.R.T test. Then press “Start” to run the test.

Quick Test: Runs a quick S.M.A.R.T test. The test usually takes less than 10 minutes. This test will check the electrical, mechanical, and read performance of the hard drive. The results are displayed as Passed/Failed on the web UI and can also be sent as an e-mail alert.

Extended Test: Runs an extended S.M.A.R.T test. This test requires a lot more time to complete. However, it is a more thorough and complete test when compared to the Quick Test.

Send result by E-mail: Enable this function in order to have the results of the S.M.A.R.T test sent to you by e-mail.

Create Schedule: Click on this button in order to create a scheduled S.M.A.R.T test. You will be able to schedule a test on a daily, weekly, and monthly basis.

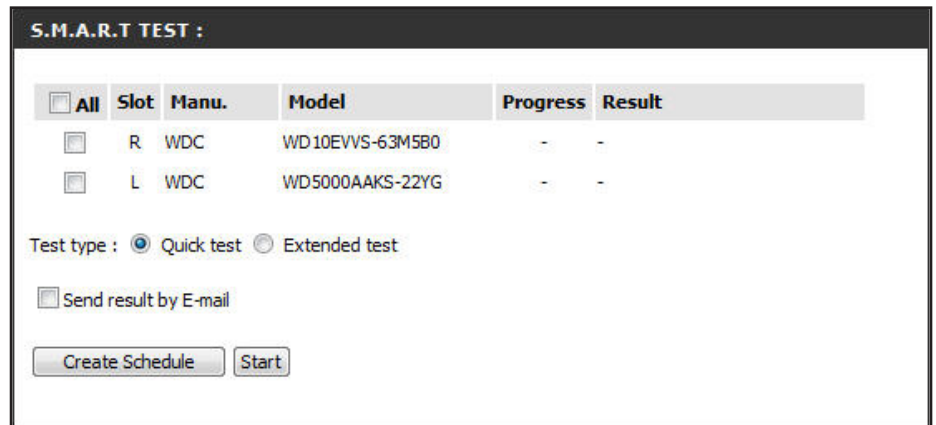
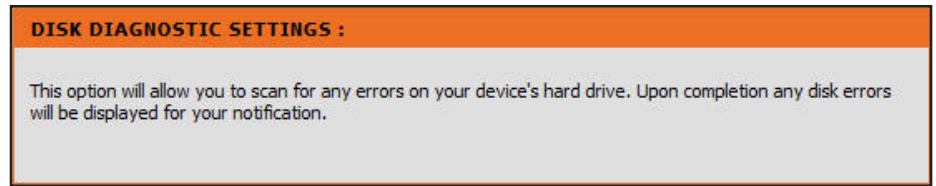

S.M.A.R.T Result: After the S.M.A.R.T test finished, the 'Result' will be displayed.

S.M.A.R.T TEST :

<input type="checkbox"/> All	Slot	Manu.	Model	Progress	Result
<input type="checkbox"/>	R	WDC	WD10EVVS-63M5B0	-	Pass[2010/07/26 11:09:48]
<input type="checkbox"/>	L	WDC	WD5000AAKS-22YG	-	-

Test type : Quick test Extended test

Send result by E-mail

Schedule: By clicking the 'Create Schedule' button the user can create a S.M.A.R.T test schedule where this test will run automatically at the configured time.

Select the frequency (Daily, Weekly, Monthly) and the Time here. Click on the 'Create' button to add a schedule.

SCHEDULE :

Daily Time : 00 : 00

Schedule List: In the window all the created schedule lists will be displayed.
To remove a schedule, simply click on the trash can icon.

SCHEDULE LIST :

Type	Slot / Volume	SCHEDULE	Delete
S.M.A.R.T - Quick	Right	00:00 / Daily	

Status Section

System Info: View a summary of the device information here.

Hard Drive Info: View a summary of the hard drive information here.

Logs: Use this option to view the NAS system logs and the FTP logs.

DNS-320		SETUP	ADVANCED	MAINTENANCE	STATUS	SUPPORT
System Info	DEVICE INFORMATION :					Helpful Hints..
Hard Drive Info	View a summary of the device information here.					
Logs	LAN Info					
Logout	IP Address: 192.168.69.32 Subnet Mask: 255.255.255.0 Gateway IP Address: 192.168.69.1 Mac Address: 00:32:30:D1:00:01 DNS1: 192.168.69.1 DNS2:					
	Device Info					
	Workgroup: workgroup Name: dlink-d10001 Description: DNS-320 System Temperature: 120°F/49°C Current Rx/Tx: 5886/7648 System Up Time: 0 day 0 hour 56 minutes					
	Volume Info					
	Volume Name: Volume_1 Volume Type: RAID 1 Sync Time Remaining: Completed Total Hard Drive Capacity: 489205 MB Used Space: 207 MB Unused Space: 488998 MB					

System Info Page

View a summary of the device information here.

LAN Info: Displays the local network settings of the ShareCenter Pulse.

Device Info: Displays the workgroup, name, description and current temperature of the ShareCenter Pulse.

Volume Info: Displays the hard drive information, including the disk mode, total size, used and remaining drive space.

DEVICE INFORMATION :

View a summary of the device information here.

LAN INFORMATION :

IP Address : 192.168.69.32
Subnet Mask : 255.255.255.0
Gateway IP Address : 192.168.69.1
Mac Address : 00:32:30:D1:00:01
DNS1 : 192.168.69.1
DNS2 :

DEVICE INFORMATION :

Workgroup : workgroup
Name : dlink-d10001
Description : DNS-320
System Temperature : 116°F/47°C
Current Rx/Tx : 24970/31722
System Up Time : 0 day 3 hours 24 minutes

VOLUME INFORMATION :

Volume Name : Volume_1
Volume Type : RAID 1
Sync Time Remaining : Completed
Total Hard Drive Capacity : 489205 MB
Used Space : 207 MB
Unused Space : 488998 MB

Hard Drive Info Page

This section will display a summary of the hard drive(s) currently installed in the ShareCenter Pulse. The summary will include information such as the hard drive manufacturer, model, serial number, temperature, total capacity size, and status. The “Status” of the hard drive will display the health of the hard drive. If your hard drive is healthy, the status will display “Normal”. If your hard drive is not healthy, the status will display “Abnormal”. At any time, if you wish to view the S.M.A.R.T table of the hard drive, you can press the “Normal/Abnormal” button.

HARD DRIVE INFO. :

View a summary of the hard drive information here.

HARD DRIVE INFO. :

Slot	Manu.	Model	Serial Number	Temp	Size	Status
R	WDC	WD10EVVS-63M5B0	WD-WCAV52163551	40°C / 104°F	1000 GB	Normal
L	WDC	WD5000AAKS-22YGA	WD-WCAS85512740	44°C / 111°F	500 GB	Normal

Slot R S.M.A.R.T Info

ID	Item	Now	Worst	Thresh	Raw Value
1	Raw_Read_Error_Rate	200	200	51	0
3	Spin_Up_Time	112	108	21	7358
4	Start_Stop_Count	100	100	0	651
5	Reallocated_Sector_Ct	200	200	140	0
7	Seek_Error_Rate	200	200	0	0
9	Power_On_Hours	97	97	0	2424
10	Spin_Retry_Count	100	100	0	0
11	Calibration_Retry_Count	100	100	0	0
12	Power_Cycle_Count	100	100	0	204
192	Power-Off_Retract_Count	200	200	0	196
193	Load_Cycle_Count	169	169	0	93849
194	Temperature_Celsius	107	99	0	40
196	Reallocated_Event_Count	200	200	0	0
197	Current_Pending_Sector	200	200	0	0
198	Offline_Uncorrectable	200	200	0	0
199	UDMA_CRC_Error_Count	200	200	0	0
200	Multi_Zone_Error_Rate	200	200	0	0

HARD DRIVE INFO. :

Slot	Manu.	Model	Serial Number	Temp	Size	Status
R	WDC	WD10EVVS-63M5B0	WD-WCAV52163551	38°C / 100°F	1000 GB	Normal
L	WDC	WD5000AAKS-22YGA	WD-WCAS85512740	31°C / 87°F	500 GB	Normal

Slot L S.M.A.R.T Info

ID	Item	Now	Worst	Thresh	Raw Value
1	Raw_Read_Error_Rate	200	200	51	0
3	Spin_Up_Time	184	8	21	5766
4	Start_Stop_Count	99	99	0	1160
5	Reallocated_Sector_Ct	200	200	140	0
7	Seek_Error_Rate	200	200	51	0
9	Power_On_Hours	96	96	0	3646
10	Spin_Retry_Count	100	100	51	0
11	Calibration_Retry_Count	100	100	51	0
12	Power_Cycle_Count	100	100	0	447
192	Power-Off_Retract_Count	200	200	0	626
193	Load_Cycle_Count	200	200	0	1381
194	Temperature_Celsius	119	83	0	31
196	Reallocated_Event_Count	200	200	0	0
197	Current_Pending_Sector	200	200	0	0
198	Offline_Uncorrectable	200	200	0	0
199	UDMA_CRC_Error_Count	200	200	0	0
200	Multi_Zone_Error_Rate	200	200	51	0

Logs Page

Use this option to view the NAS system logs and the FTP logs.

System Log: View the System log.

LOGS :

Use this option to view the NAS system logs and the FTP logs.

 Clear Log

Date	Time	Info
Jan 14	00:54:05	System Has Rebooted From A Power Failure.
Jan 14	00:54:08	System up
Jan 14	00:54:13	fan_control mode is [auto: high/low/stop]
Jan 14	00:54:14	change fan speed to stop.
Jan 14	00:59:44	System shutdown.
Jan 16	07:56:27	System Has Rebooted From A Power Failure.
Jan 16	07:56:29	System up
Jan 16	07:56:32	fan can't stop or fan doesn't exist.
Jan 16	07:56:35	fan can't stop or fan doesn't exist.
Jan 16	07:56:35	fan_control mode is [auto: high/low/stop]

10 Page 1 of 22 Displaying 1 to 10 of 213 items

Support Section

Support: In the Support Section, the user can find more information about every feature listed on this device.

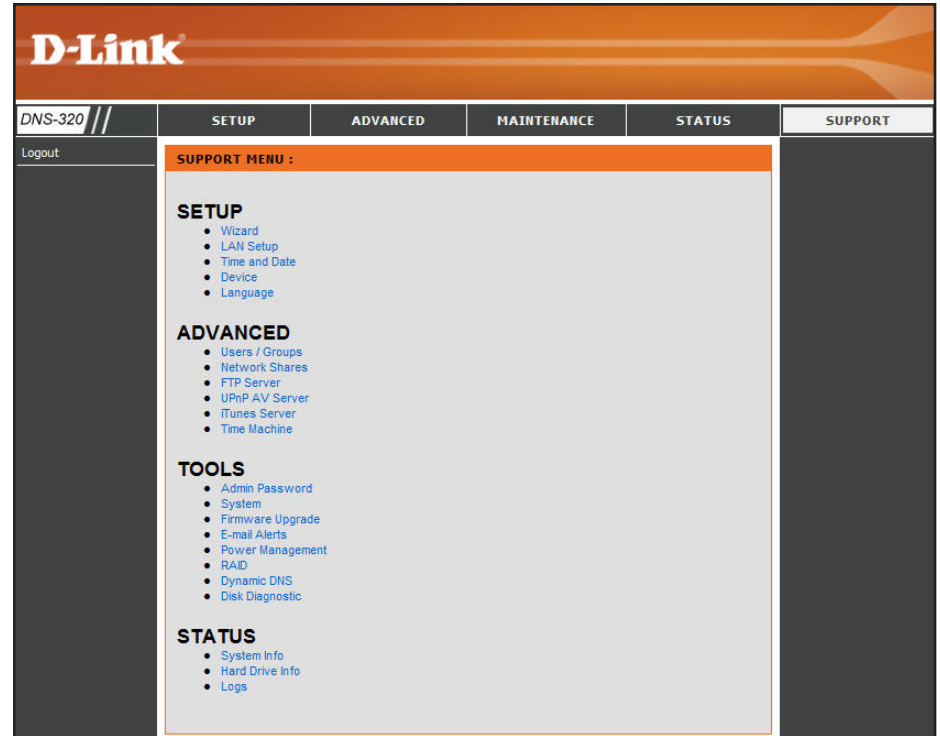

Schedule Downloads Section

Local Backups: Schedule local file and folder backups from the local network share. Always test the URL before applying changes. This will help to ensure a successful download.

FTP/HTTP Downloads: Schedule file and folder backups from an FTP server, web server, or local network share. Always test the URL before applying changes. This will help to ensure a successful download.

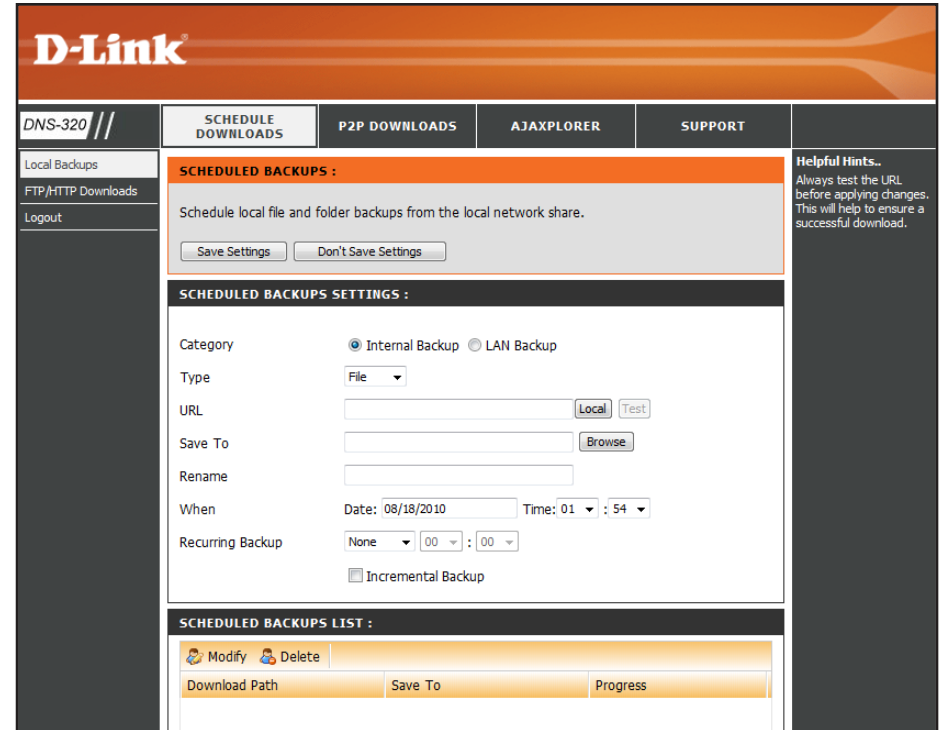

Local Backups Page

Schedule local file and folder backups from the local network share of the device or from the local computer. Always test the URL before applying changes. This will help to ensure a successful download.

Category: Use the radio buttons to select the backup method. If your NAS device has two volumes you can click the Internal Backup radio button to backup the data from the first volume to the second volume and vice-versa. The Internal Backup feature also allows you to backup an existing folder on a volume to another folder on the same volume but nested folders in the same volume are not allowed.

Login Method: If you want to backup the data from your PC or another NAS device to your NAS device, click the LAN Backup radio button.

Enter the login information for the site that contains the files that you want to schedule downloads from. If no password is required choose 'Anonymous'. If a password is required choose 'Account' and provide the user name and password. This option is only available for LAN Backups.

User Name: Enter the user name used here.

Password: Enter the password used here.

Type: Select File or Folder, depending on what you want to download or backup.

URL: Enter the URL of the site or server you are initiating a transfer from. E.g. ftp://123.456.789/Test or ftp://123.456.789/test.txt

Save To: Enter a valid destination drive on the ShareCenter Pulse, or click Browse to select the destination.

Rename: Enter the renamed file name here.

When: Enter the date and time you want the scheduled backup or download to initiate.

Recurring Backup: Designate the interval and time you want the backup or download to run unattended.

Incremental Backup: By default all local backups and file/folder downloads are in Overwrite mode, meaning that identical files in the destination folder will be overwritten by the source files. Checking Incremental Backup will have the ShareCenter Pulse compare identical file names at the source and destination. Files will only be overwritten if the source file is more recent.

SCHEDULE BACKUPS :

Schedule local file and folder backups from the local network share.

SCHEDULE BACKUPS SETTINGS :

Category Internal Backup LAN Backup

Login Method Account Anonymous

User Name

Password

Type

URL

Save To

Rename

When Date: Time: :

Recurring Backup : :

Incremental Backup

Schedule List: The Schedule List will display all completed, active, and pending scheduled downloads and backups.

In this window the user can also modify an entry by clicking on the 'Edit' button, and remove an entry by clicking on the 'Delete' button.

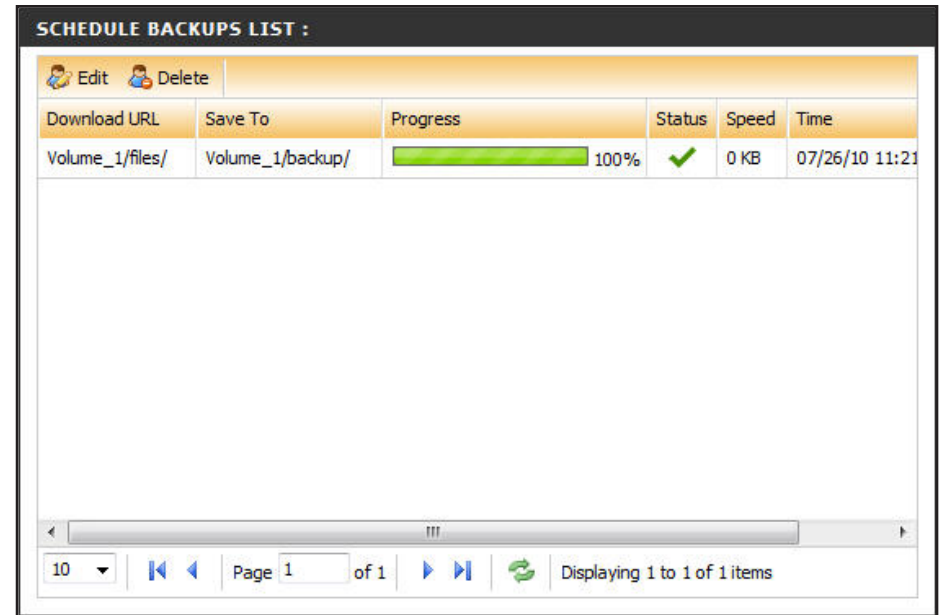

SCHEDULE BACKUPS LIST :

Download URL	Save To	Progress	Status	Speed	Time
Volume_1/files/	Volume_1/backup/	<div style="width: 100%;"><div style="width: 100%;"></div></div> 100%	✓	0 KB	07/26/10 11:21

10 Page 1 of 1 Displaying 1 to 1 of 1 items

FTP/HTTP Downloads Page

Schedule file and folder backups from an FTP server, web server, or local network share. Always test the URL before applying changes. This will help to ensure a successful download.

Category: Use the radio buttons to select the type of server that the source files/folders for the Schedule Downloads are located on. Click the HTTP radio button to specify that the source files are located on a web server. Click the FTP radio button to specify that the source files/folders are located on an FTP server.

Login Method: Enter the login information for the site that contains the files that you want to schedule for downloading. If no password is required, choose 'Anonymous'. If a password is required, choose 'Account' and provide the user name and password.

User Name: Enter the user name here.

Password: Enter the password here.

Type: Select either 'File' or 'Folder' from the drop-down list depending on whether you wish to download a file or a folder. Choose 'File' if you wish to download a specific file. Choose 'Folder' if you wish to download all the files in a specific folder.

URL: Enter the FTP/ HTTP site address for the scheduled download. Click on 'Test' to verify access to the site address and file/folder. If you have chosen 'File' from the above drop down list, you must specify the exact file in the URL path, including the file extension. (e.g. http://example.com/test/testfile.txt).

Save To: Enter the specific destination on the internal drives for the downloaded files or folders to be saved to. Click 'Browse' to browse the internal drives.

SCHEDULE DOWNLOADS SETTINGS :

Schedule file and folder backups from an FTP server, web server, or local network share.

SCHEDULE DOWNLOADS SETTINGS :

Category HTTP FTP

URL

Save To

Rename

When Date: Time: :

Recurring Backup :

SCHEDULE DOWNLOADS SETTINGS :

Category HTTP FTP

Login Method Account Anonymous

User Name

Password

Type

URL

Save To

Rename

Language

When Date: Time: :

Recurring Backup :

Rename: If you would like to rename a file after it has been downloaded from the specified HTTP/FTP server, enter the name you would like the file to be renamed to in this field.

Language: Use the drop-down menu to select the language used in the file or folder that you are trying to download.

When: Select the date and time for the download to occur.

Recurring Backup: If you wish to schedule a recurring backup, select the desired interval (daily, weekly, or monthly) and the time you want the backup to start.

Incremental Backup: This type of backup, if used, will compare files of identical names on both the source and destination folders. If the source file was modified later than the destination file, the source file will overwrite the existing (old) destination file. If the source file is the same as the destination file, no action will be taken.

Schedule Download List: Pending and completed download events will be listed here. The current status for each event is displayed here. In addition, there is an option to delete a download event at any time. Current download statistics, such as % completed and download speed, are displayed for each event. A refresh button is also provided to produce updated listings at any time.

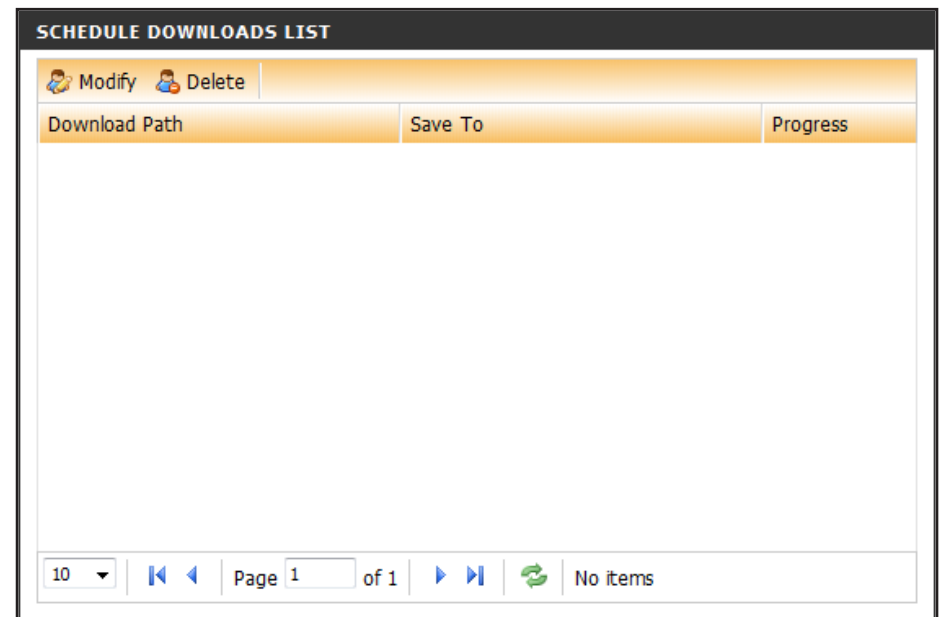

P2P Downloads Section

Downloads: On this page the user can add, view and remove current downloads.

Setting: On this page the user can configure the P2P download manager settings.

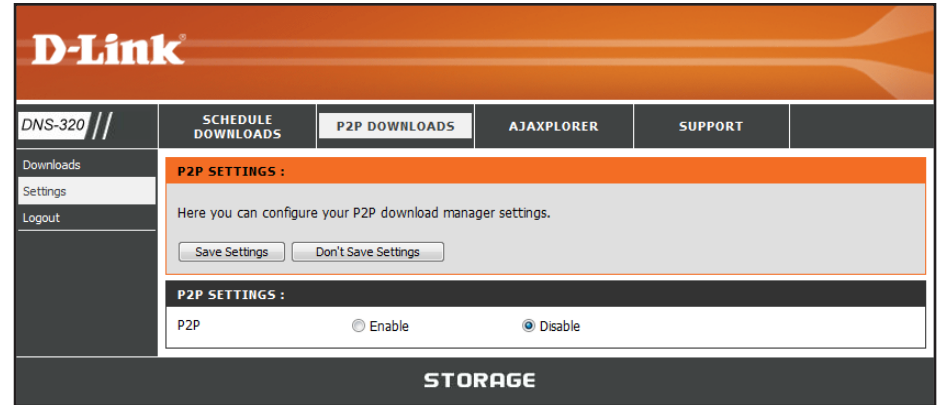

Downloads Page

Here the user can configure the Peer-to-Peer download manager settings.

Add torrent from

URL: In the field provided you can copy and paste a link to a torrent file hosted on the internet. The BitTorrent download manager will add the torrent file to the download manager and being downloading your files.

Add torrent from File: Here you can browse for a torrent file you have downloaded onto your PC.

P2P Tasks: This allows you to load the torrent file from your local PC. In this windows all the running tasks will be displayed.

Remove Completed: The user can click on the 'Remove Completed' button to remove finished downloads. Sometimes identifying finished jobs, when multiple downloads exist, can be difficult. This option make is easy for the user to remove finished downloads from the list with a single click.

Details: The 'Details' button allows the user to view the files that are being downloaded for each torrent.

Top, Up, Down, Bottom: The 'Top', 'Up', 'Down' and 'Bottom' buttons allows the user to move the selected P2P download in the task list. The downloads at the top of the list carries more priority than the one list below them.

Delete: The 'Delete' button allows the user to remove a selected download. This will remove not only the torrent file, but also the partially downloaded files too.

Start/Stop: The start and stop button allows the user to start and stop selected P2P downloads in the task list.

Torrent Scheduling: The 'Torrent Scheduling' button allows the user to configure a scheduling rule for the select P2P downloading task.

Navigation: At the bottom of the P2P Task window there are a couple of navigation controls. When multiple tasks exist, the user can select how many tasks will be displayed by using the drop-down menu. The user can also navigate to next pages when more than one page exist.

Refresh: The refresh button allows the user to refresh the P2P task list to display the most updated statistics.

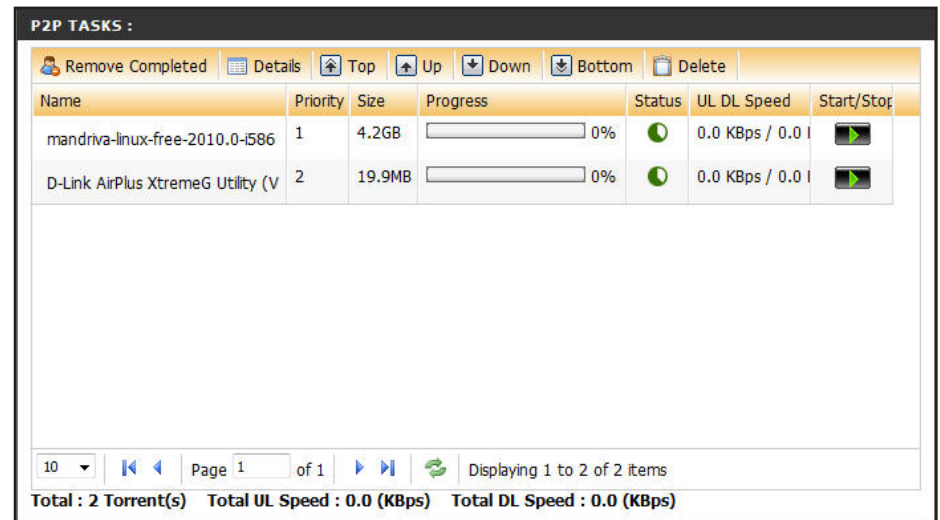
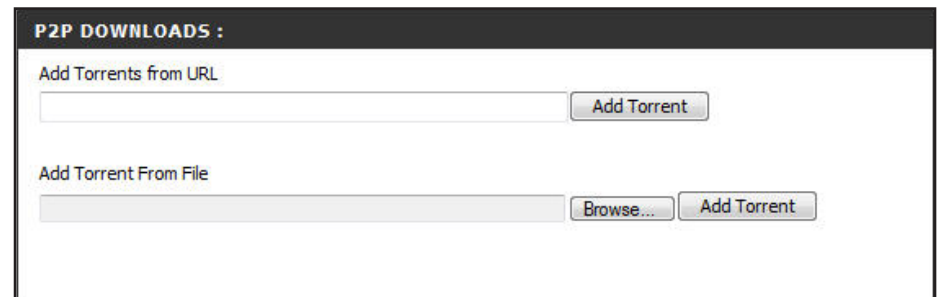
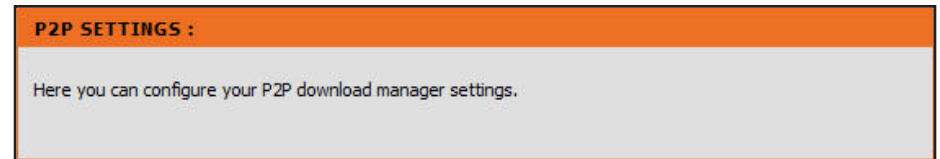

Setting Page

On this page the user can configure the P2P download manager settings.

P2P: Here the user can enable or disable the peer to peer function.

Start/Stop: In the block provided the user can configure the running schedule for P2P downloads. Simply select the 'Start' and 'Stop' block for the appropriate Date and Time.

Auto Download: Here the user can enable or disable the automatic download option.

Port Settings: Here the user can choose to allow the device to automatically choose an incoming connections port or you can configure the incoming connections port manually.

Seeding: Here the user can configure some seeding options.

Torrent Save Path: Here the torrent path will be displayed.

Encryption: Here the user can choose to enable or disable the encryption used.

Bandwidth Control: Here the user can choose to allow the device to automatically choose the bandwidth control speed, or you can manually configure the maximum download rate and maximum upload rate. Enter the value '-1' to set the respective field to 'unlimited'.

Ajaxplorer Section

Launch: This section allows you to configure the AjaXplorer function. AjaXplorer is a file explorer that allows you to remotely manage the files stored under the AjaXplorer folder by using a web browser.

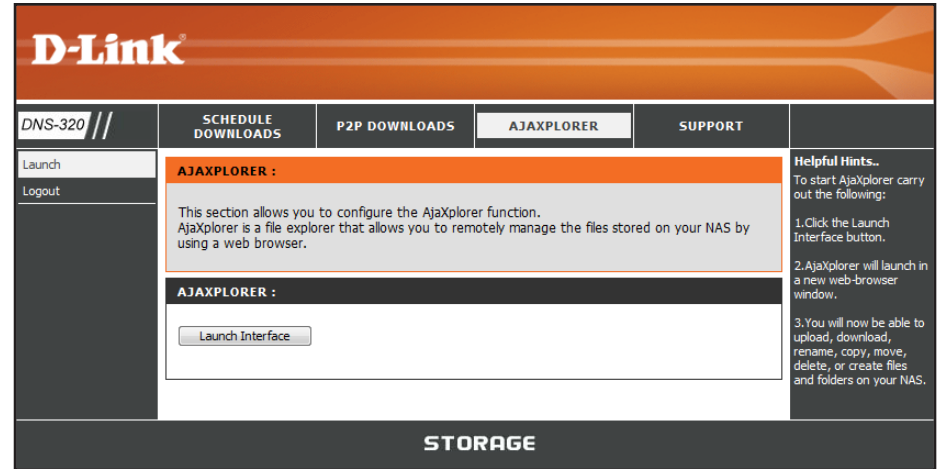

Launch Page

On this page you can launch the AjaXplorer.

Launch Interface: To launch the AjaXplorer's Interface for configuration, click on the 'Launch Interface' button.

Below is what the Interface looks like. You will now be able to upload, download, rename, copy, move, delete, or create files and folders on your NAS.

AJAXPLORER :

This section allows you to configure the AjaXplorer function. AjaXplorer is a file explorer that allows you to remotely manage the files stored on your NAS by using a web browser.

AJAXPLORER :

Launch Interface

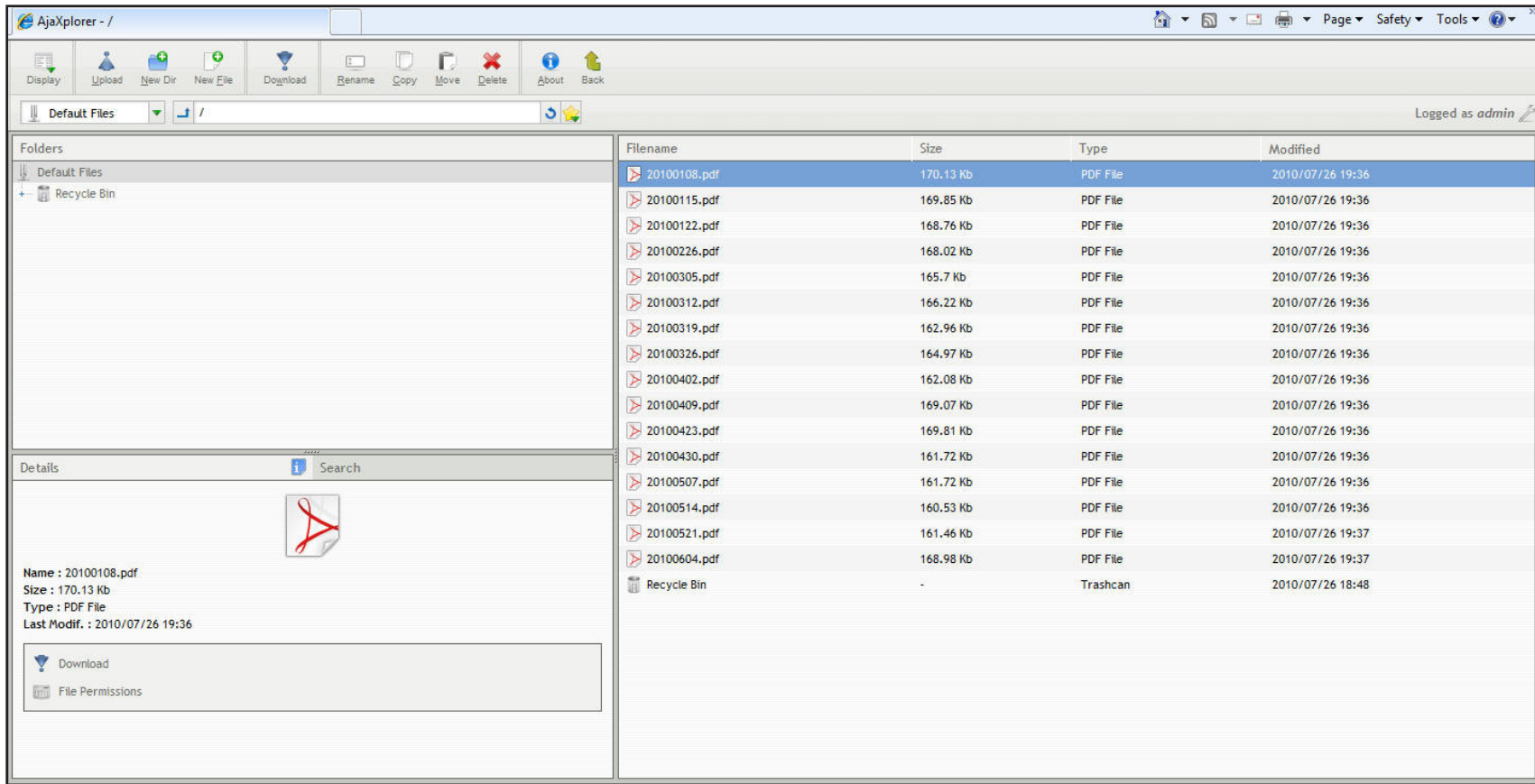

Support Section

Support: In the Support Section, the user can find more information about every feature listed on this device.

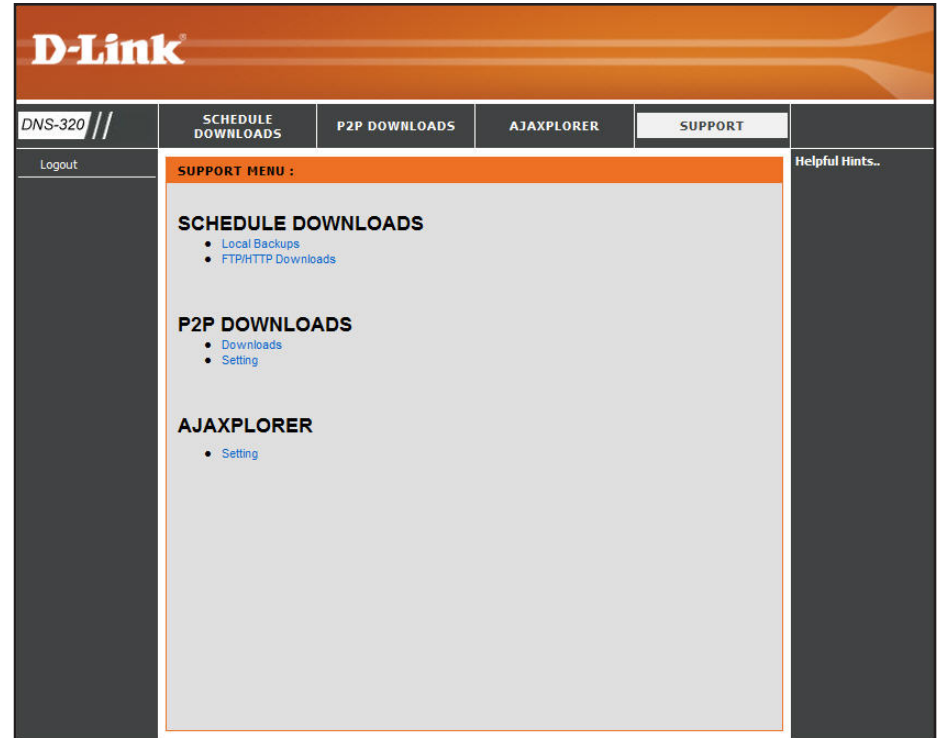

Knowledge Base

Mapping a Drive

You can use the D-Link Easy Search Utility to map drives to your computer. Insert the DNS-320 CD into your CD-ROM drive.



1. Click Easy Search Utility. The Easy Search Utility will load and detect any DNS-320 devices that are on the local network. If the ShareCenter Pulse you are working with does not show up in the device list, click Refresh.

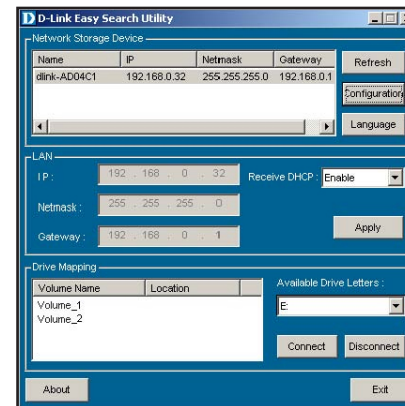

2. Highlight an available ShareCenter Pulse. Available volumes will be displayed under Drive Mapping. Highlight the volume you want to map. Select an available drive letter from the drop-down menu and click Connect. Once connected, your mapped drive(s) will appear in My Computer.

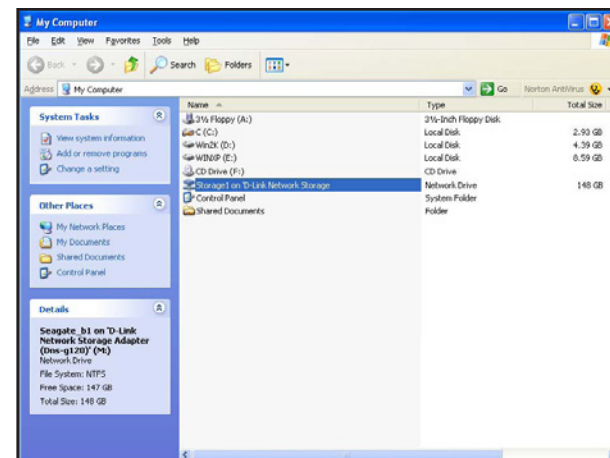

3. Double-click the My Computer icon on your desktop. Double-click on the mapped drive to access the files and folders.

Replacing or Adding a New Hard Drive

It is recommended that you backup your important files before replacing or adding a new hard drive to the ShareCenter Pulse.

Replacing a Hard Drive:

Please make sure the power is off before replacing a hard drive. After you have installed the new drive, turn on the ShareCenter Pulse and then connect to the Web UI. The ShareCenter Pulse will prompt you to format the new drive (Standard, RAID 1 mode) or both drives (JBOD, RAID 0 mode).

Adding a New Hard Drive:

The ShareCenter Pulse is able to work with one single hard drive under Standard mode. Please make sure the power is off before installing a second hard drive. After you have installed the new drive, turn on the ShareCenter Pulse and then connect to the Web UI. The ShareCenter Pulse will prompt you to format the new drive.

Note: Formatting a hard drive will erase the data stored on the hard drive. Please backup important data before formatting a hard drive.

Secure HTTP Login

Apart from logging into the web user interface using the normal <http://192.168.69.32/>, user can also login to the web configuration using secure https.

- 1) Open Internet Explorer and type <https://192.168.0.32>
- 2) Login to the ShareCenter Pulse as per normal.

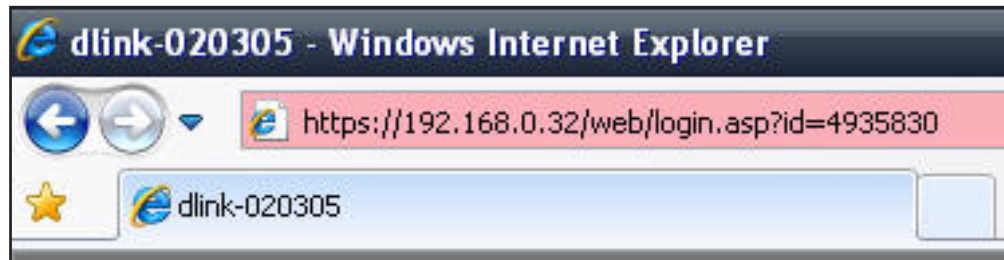

What is RAID?

RAID, short for Redundant Array of Independent Disks, is a combination of two or more disks with the aim of providing fault tolerance and improving performance. There are several different levels of RAID, with each providing a different method of sharing or distributing data amongst the drives. The ShareCenter Pulse supports RAID levels 0 and 1.

RAID 0

RAID 0 provides data striping, which spreads out blocks of data over both drives, but does not provide data redundancy. Although performance is improved, the lack of fault tolerance means that if one drive fails, all data in the array will be lost.

RAID 1

RAID 1 provides mirroring over both disks, with the same read/write speed of a single disk. A RAID 1 array can only be as large as its smallest member disk. Because the data is stored on both disks, RAID 1 provides fault tolerance and protection, in addition to performance advantages.

RAID 0

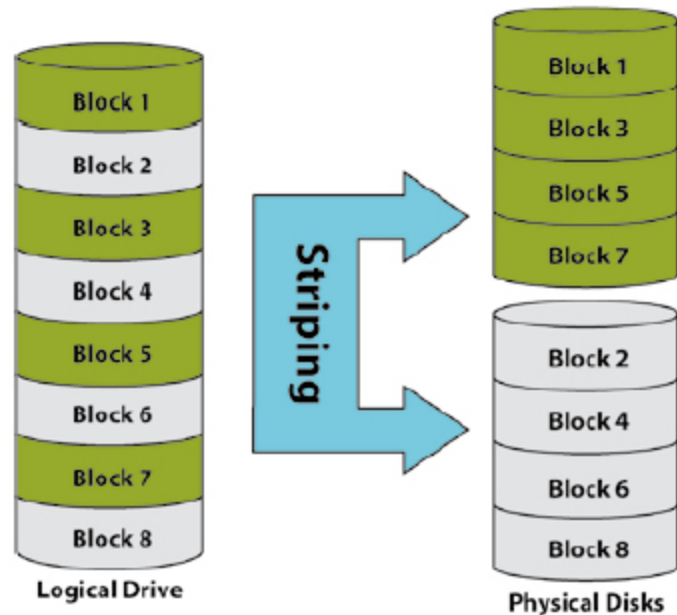

RAID 1

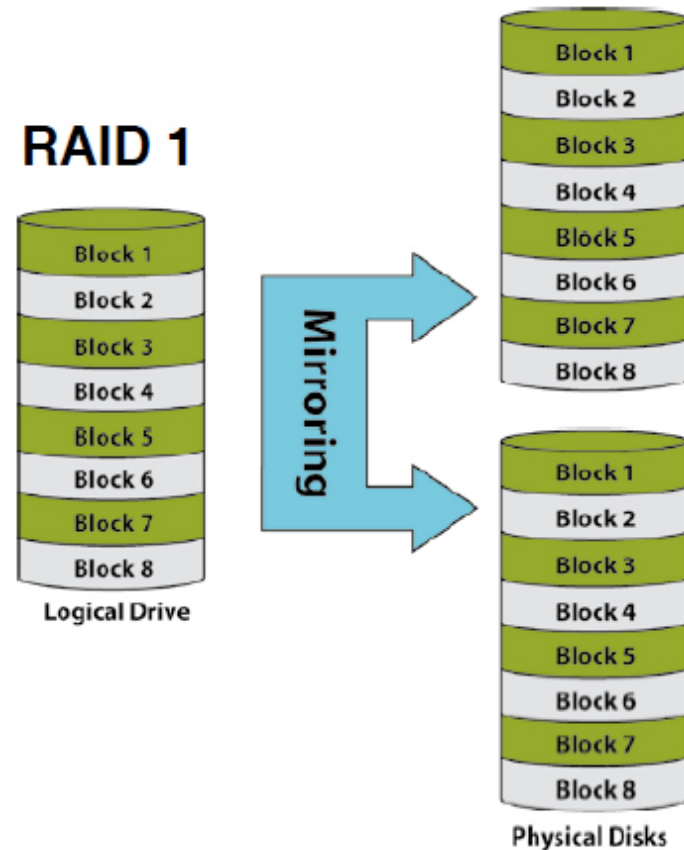

RAID 1 - Auto Rebuilding

When a hard drive fails or becomes corrupted RAID 1 provides a the feature to enable the Auto Rebuild configuration. This configuration will take the information from one of the existing hard drives and rebuild the new hard drive with the same information to get the RAID 1 configuration completed.

Information: To view the hard drive status you can go to STATUS > SYSTEM INFO and monitor the Sync Time Remaining field. If it displays 'Completed' the RAID 1 configuration is functioning normal.

Degraded: However if it displays 'Degraded' then one of the hard drives have either failed or is starting to fail. This mean that the problematic hard drive needs to be replaced.

Step 1: After the new hard drive is inserted into the ShareCenter Pulse go to **TOOLS > RAID** and you'll now have the option to start the **Auto Rebuilding** process if Auto Rebuild was disabled from the beginning. If Auto Rebuild was enabled from the beginning the ShareCenter Pulse will start this Rebuilding process automatically.

You can now click the **Manually Rebuild Now** button to initiate the Auto Rebuilding process.

Volume Info	
Volume Name	Volume_1
Volume Type	RAID 1
Sync Time Remaining	Completed
Total Hard Drive Capacity	489205 MB
Used Space	207 MB
Unused Space	488998 MB

Volume Info	
Volume Name	Volume_1
Volume Type	RAID 1
Sync Time Remaining	Degraded
Total Hard Drive Capacity	489205 MB
Used Space	1161 MB
Unused Space	488044 MB

RAID CONFIGURATION :	
Current RAID Type	
Volume_1 : RAID 1 (Degraded)	
<input type="button" value="Set RAID Type and Re-Format"/>	
<input type="button" value="Create A New Volume From The Remaining Available Storage Space"/>	

AUTO-REBUILD CONFIGURATION :	
<input type="radio"/> Enable Auto-Rebuild <input checked="" type="radio"/> Disable Auto-Rebuild	
<input type="button" value="Manually Rebuild Now"/>	
<input type="button" value="Apply"/>	

RAID 1 - Auto Rebuilding (continued)

Step 2: After clicking the Manually Rebuild Now button the **Synchronizing** will start and take some time to finish.

Monitoring: To monitor the progress of the Auto Rebuilding process you can go to **STATUS > SYSTEM INFO** and monitor the **Sync Time Remaining** to know how far the Rebuilding process is.

Alternatively you can also use your **Yahoo! Widget** to monitor the progress of the Rebuilding process.

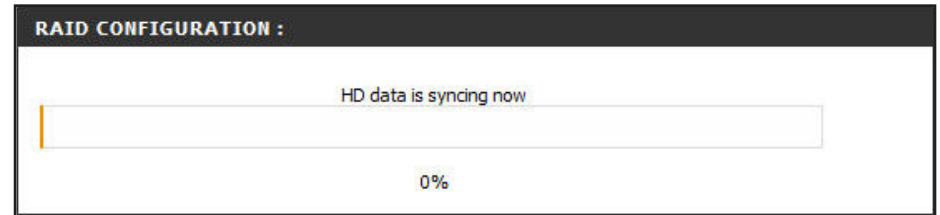

Volume Info	
Volume Name	Volume_1
Volume Type	RAID 1
Sync Time Remaining	2 % complete
Total Hard Drive Capacity	489205 MB
Used Space	1161 MB
Unused Space	488044 MB

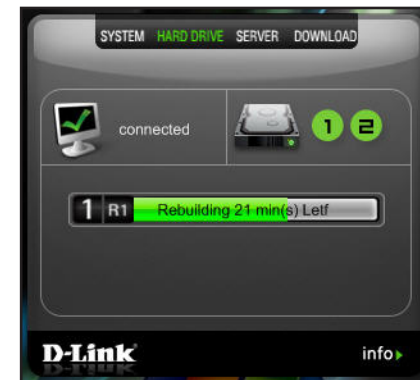

Yahoo! Widget Installation

D-Link provides an added feature to the ShareCenter called a Yahoo! Widget.

What is a Yahoo! Widget?

Yahoo! Widgets are free application platforms that can be used in Microsoft Windows and Mac OS X. The engine uses a JavaScript runtime environment combined with an XML interpreter to run small applications referred to as widgets, and hence is part of a class of software applications called widget engines.

Step 1: Install the Yahoo! Widget downloaded. Once the Yahoo! Widget is installed a D-Link icon will appear in your Widget Dock. Once you hover with your mouse over the D-Link Widget you'll be able to click the configuration button.

Step 2: Click the configuration button to configure the Widget. Enter the IP Address of your ShareCenter Pulse and click on the Save button.
Now your ready to use your new D-Link Yahoo! Widget!



Yahoo! Widget Display

The D-Link Widget is mainly used for monitoring the activities taking place on your ShareCenter Pulse.

System: In the System window information about your Computer, ShareCenter Pulse, IP Address, Firmware Version and Current Operational Temperature are displayed.

Hard Drive: In the Hard Drive window information about the storage space of your ShareCenter Pulse is displayed.

Server: In the Server window information about the USB Device, UPnP Server, iTunes and FTP Server configured on your ShareCenter Pulse is displayed.

Dwonload: When the P2P Application is loaded, you can monitor your P2P download status here.



Technical Specifications

Physical and Environmental	
Operating Temp	: 0 ~ 40°C
Operating Humidity	: 90% Maximum (Non-condensing)
Storage Temp	: -20 ~ 50°C
Storage Humidity	: 5 ~ 90% (Non-condensing)
Dimensions	: Item: 18.2 x 14.6 x 11.3 cm (h/l/w) Packaging: 18.2 x 14.6 x 11.3 cm (h/l/w)
Weight	: 0.8 kg
EMI	: FCC Class B, CE, VCCI, CSA, C-Tick, UL

Specifications	
Standards	: IEEE 802.3 10Base-T Ethernet IEEE 802.3u 100Base-TX Fast Ethernet
Support Hard Drive Type	: SATA I/ II
Drive Management	: Four Different Hard Drive Configurations Disk Diagnostics E-mail Alerts Drive Quotas Power Management
Device Management	: Internet Explorer version 7.0 or Mozilla Firefox 3.0 and above

Hardware	
Power Adapter	: 12V/4A
Ethernet Port	: 1 x 10/100/1000 Gigabit Ethernet Port
Reset button	: Reset to factory default settings
LED Indicators	: Power, LAN, HDD1, HDD2, USB

Contacting Technical Support

U.S. and Canadian customers can contact D-Link technical support through our web site or by phone.

Before you contact technical support, please have the following ready:

- Model number of the product (e.g. ShareCenter Pulse)
- Hardware Revision (located on the label on the bottom of the switch (e.g. rev A1))
- Serial Number (s/n number located on the label on the bottom of the device).

You can find software updates and user documentation on the D-Link website as well as frequently asked questions and answers to technical issues.

For customers within the United States:

Phone Support:
(877) 453-5465

Internet Support:
<http://support.dlink.com>

For customers within Canada:

Phone Support:
(800) 361-5265

Internet Support:
<http://support.dlink.com>

Warranty

Subject to the terms and conditions set forth herein, D-Link Systems, Inc. (“D-Link”) provides this Limited Warranty:

- Only to the person or entity that originally purchased the product from D-Link or its authorized reseller or distributor.
- Only for products purchased and delivered within the fifty states of the United States, the District of Columbia, U.S. Possessions or Protectorates, U.S. Military Installations, or addresses with an APO or FPO.

Limited Warranty:

D-Link warrants that the hardware portion of the D-Link product described below (“Hardware”) will be free from material defects in workmanship and materials under normal use from the date of original retail purchase of the product, for the period set forth below (“Warranty Period”), except as otherwise stated herein.

- Hardware (excluding power supplies): One (1) year
- Free Technical Support - Basic Installation: Ninety (90) days

The customer’s sole and exclusive remedy and the entire liability of D-Link and its suppliers under this Limited Warranty will be, at D-Link’s option, to repair or replace the defective Hardware during the Warranty Period at no charge to the original owner or to refund the actual purchase price paid. Any repair or replacement will be rendered by D-Link at an Authorized D-Link Service Office. The replacement hardware need not be new or have an identical make, model or part. D-Link may, at its option, replace the defective Hardware or any part thereof with any reconditioned product that D-Link reasonably determines is substantially equivalent (or superior) in all material respects to the defective Hardware. Repaired or replacement hardware will be warranted for the remainder of the original Warranty Period or ninety (90) days, whichever is longer, and is subject to the same limitations and exclusions. If a material defect is incapable of correction, or if D-Link determines that it is not practical to repair or replace the defective Hardware, the actual price paid by the original purchaser for the defective Hardware will be refunded by D-Link upon return to D-Link of the defective Hardware. All Hardware or part thereof that is replaced by D-Link, or for which the purchase price is refunded, shall become the property of D-Link upon replacement or refund.

Limited Software Warranty:

D-Link warrants that the software portion of the product (“Software”) will substantially conform to D-Link’s then current functional specifications for the Software, as set forth in the applicable documentation, from the date of original retail purchase of the Software for a period of ninety (90) days (“Software Warranty Period”), provided that the Software is properly installed on approved hardware and operated as contemplated in its documentation. D-Link further warrants that, during the Software Warranty Period, the magnetic media on which D-Link delivers the Software will be free of physical defects. The customer’s sole and exclusive remedy and the entire liability of D-Link and its suppliers under this Limited Warranty will be, at D-Link’s option, to replace the non-conforming Software (or defective media) with software that substantially conforms to D-Link’s functional specifications for the Software or to refund the portion of the actual purchase price paid that is attributable to the Software. Except as otherwise agreed by D-Link in writing, the replacement Software is provided only to the original licensee, and is subject to the terms and conditions of the license granted by D-Link for the Software. Replacement Software will be warranted for the remainder of the original Warranty Period and is subject to the same limitations and exclusions. If a material non-conformance is incapable of correction, or if D-Link determines in its sole discretion that it is not practical to replace the non-conforming Software, the price paid by the

original licensee for the non-conforming Software will be refunded by D-Link; provided that the non-conforming Software (and all copies thereof) is first returned to D-Link. The license granted respecting any Software for which a refund is given automatically terminates.

Non-Applicability of Warranty:

The Limited Warranty provided hereunder for Hardware and Software portions of D-Link's products will not be applied to and does not cover any refurbished product and any product purchased through the inventory clearance or liquidation sale or other sales in which D-Link, the sellers, or the liquidators expressly disclaim their warranty obligation pertaining to the product and in that case, the product is being sold "As-Is" without any warranty whatsoever including, without limitation, the Limited Warranty as described herein, notwithstanding anything stated herein to the contrary.

Submitting A Claim:

The customer shall return the product to the original purchase point based on its return policy. In case the return policy period has expired and the product is within warranty, the customer shall submit a claim to D-Link as outlined below:

- The customer must submit with the product as part of the claim a written description of the Hardware defect or Software nonconformance in sufficient detail to allow D-Link to confirm the same, along with proof of purchase of the product (such as a copy of the dated purchase invoice for the product) if the product is not registered.
- The customer must obtain a Case ID Number from D-Link Technical Support at 1-877-453-5465, who will attempt to assist the customer in resolving any suspected defects with the product. If the product is considered defective, the customer must obtain a Return Material Authorization ("RMA") number by completing the RMA form and entering the assigned Case ID Number at <https://rma.dlink.com/>.
- After an RMA number is issued, the defective product must be packaged securely in the original or other suitable shipping package to ensure that it will not be damaged in transit, and the RMA number must be prominently marked on the outside of the package. Do not include any manuals or accessories in the shipping package. D-Link will only replace the defective portion of the product and will not ship back any accessories. • The customer is responsible for all in-bound shipping charges to D-Link. No Cash on Delivery ("COD") is allowed. Products sent COD will either be rejected by D-Link or become the property of D-Link. Products shall be fully insured by the customer and shipped to D-Link Systems, Inc., 17595 Mt. Herrmann, Fountain Valley, CA 92708. D-Link will not be held responsible for any packages that are lost in transit to D-Link. The repaired or replaced packages will be shipped to the customer via UPS Ground or any common carrier selected by D-Link. Return shipping charges shall be prepaid by D-Link if you use an address in the United States, otherwise we will ship the product to you freight collect. Expedited shipping is available upon request and provided shipping charges are prepaid by the customer. D-Link may reject or return any product that is not packaged and shipped in strict compliance with the foregoing requirements, or for which an RMA number is not visible from the outside of the package. The product owner agrees to pay D-Link's reasonable handling and return shipping charges for any product that is not packaged and shipped in accordance with the foregoing requirements, or that is determined by D-Link not to be defective or non-conforming.

What Is Not Covered:

The Limited Warranty provided herein by D-Link does not cover:

Products that, in D-Link's judgment, have been subjected to abuse, accident, alteration, modification, tampering, negligence, misuse, faulty installation, lack of reasonable care, repair or service in any way that is not contemplated in the documentation for the product, or if the model or serial number has been altered, tampered with, defaced or

removed; Initial installation, installation and removal of the product for repair, and shipping costs; Operational adjustments covered in the operating manual for the product, and normal maintenance; Damage that occurs in shipment, due to act of God, failures due to power surge, and cosmetic damage; Any hardware, software, firmware or other products or services provided by anyone other than D-Link; and Products that have been purchased from inventory clearance or liquidation sales or other sales in which D-Link, the sellers, or the liquidators expressly disclaim their warranty obligation pertaining to the product.

While necessary maintenance or repairs on your Product can be performed by any company, we recommend that you use only an Authorized D-Link Service Office. Improper or incorrectly performed maintenance or repair voids this Limited Warranty.

Disclaimer of Other Warranties:

EXCEPT FOR THE LIMITED WARRANTY SPECIFIED HEREIN, THE PRODUCT IS PROVIDED “AS-IS” WITHOUT ANY WARRANTY OF ANY KIND WHATSOEVER INCLUDING, WITHOUT LIMITATION, ANY WARRANTY OF MERCHANTABILITY, FITNESS FOR A PARTICULAR PURPOSE AND NON-INFRINGEMENT.

IF ANY IMPLIED WARRANTY CANNOT BE DISCLAIMED IN ANY TERRITORY WHERE A PRODUCT IS SOLD, THE DURATION OF SUCH IMPLIED WARRANTY SHALL BE LIMITED TO THE DURATION OF THE APPLICABLE WARRANTY PERIOD SET FORTH ABOVE. EXCEPT AS EXPRESSLY COVERED UNDER THE LIMITED WARRANTY PROVIDED HEREIN, THE ENTIRE RISK AS TO THE QUALITY, SELECTION AND PERFORMANCE OF THE PRODUCT IS WITH THE PURCHASER OF THE PRODUCT.

Limitation of Liability:

TO THE MAXIMUM EXTENT PERMITTED BY LAW, D-LINK IS NOT LIABLE UNDER ANY CONTRACT, NEGLIGENCE, STRICT LIABILITY OR OTHER LEGAL OR EQUITABLE THEORY FOR ANY LOSS OF USE OF THE PRODUCT, INCONVENIENCE OR DAMAGES OF ANY CHARACTER, WHETHER DIRECT, SPECIAL, INCIDENTAL OR CONSEQUENTIAL (INCLUDING, BUT NOT LIMITED TO, DAMAGES FOR LOSS OF GOODWILL, LOSS OF REVENUE OR PROFIT, WORK STOPPAGE, COMPUTER FAILURE OR MALFUNCTION, FAILURE OF OTHER EQUIPMENT OR COMPUTER PROGRAMS TO WHICH D-LINK’S PRODUCT IS CONNECTED WITH, LOSS OF INFORMATION OR DATA CONTAINED IN, STORED ON, OR INTEGRATED WITH ANY PRODUCT RETURNED TO D-LINK FOR WARRANTY SERVICE) RESULTING FROM THE USE OF THE PRODUCT, RELATING TO WARRANTY SERVICE, OR ARISING OUT OF ANY BREACH OF THIS LIMITED WARRANTY, EVEN IF D-LINK HAS BEEN ADVISED OF THE POSSIBILITY OF SUCH DAMAGES. THE SOLE REMEDY FOR A BREACH OF THE FOREGOING LIMITED WARRANTY IS REPAIR, REPLACEMENT OR REFUND OF THE DEFECTIVE OR NONCONFORMING PRODUCT. THE MAXIMUM LIABILITY OF D-LINK UNDER THIS WARRANTY IS LIMITED TO THE PURCHASE PRICE OF THE PRODUCT COVERED BY THE WARRANTY. THE FOREGOING EXPRESS WRITTEN WARRANTIES AND REMEDIES ARE EXCLUSIVE AND ARE IN LIEU OF ANY OTHER WARRANTIES OR REMEDIES, EXPRESS, IMPLIED OR STATUTORY.

Governing Law:

This Limited Warranty shall be governed by the laws of the State of California. Some states do not allow exclusion or limitation of incidental or consequential damages, or limitations on how long an implied warranty lasts, so the foregoing limitations and exclusions may not apply. This Limited Warranty provides specific legal rights and you may also have other rights which vary from state to state.

Trademarks:

D-Link is a registered trademark of D-Link Systems, Inc. Other trademarks or registered trademarks are the property of their respective owners.

Copyright Statement:

No part of this publication or documentation accompanying this product may be reproduced in any form or by any means or used to make any derivative such as translation, transformation, or adaptation without permission from D-Link Corporation/D-Link Systems, Inc., as stipulated by the United States Copyright Act of 1976 and any amendments thereto. Contents are subject to change without prior notice.

Copyright ©2010 by D-Link Corporation/D-Link Systems, Inc. All rights reserved.

CE Mark Warning:

This is a Class A product. In a domestic environment, this product may cause radio interference, in which case the user may be required to take adequate measures.

Federal Communication Commission (FCC) Statement:

This equipment has been tested and found to comply with the limits for a Class B digital device, pursuant to Part 15 of the FCC Rules. These limits are designed to provide reasonable protection against harmful interference in a residential installation. This equipment generates, uses and can radiate radio frequency energy and, if not installed and used in accordance with the instructions, may cause harmful interference to radio communications. However, there is no guarantee that interference will not occur in a particular installation. If this equipment does cause harmful interference to radio or television reception, which can be determined by turning the equipment off and on, the user is encouraged to try to correct the interference by one of the following measures:

- Reorient or relocate the receiving antenna.
- Increase the separation between the equipment and receiver.
- Connect the equipment into an outlet on a circuit different from that to which the receiver is connected.
- Consult the dealer or an experienced radio/TV technician for help.

This device complies with Part 15 of the FCC Rules. Operation is subject to the following two conditions:

1. this device may not cause harmful interference, and
2. this device must accept any interference received, including interference that may cause undesired operation.

Warning: Changes or modifications to this unit not expressly approved by the party responsible for compliance could void the user authority to operate the equipment.

Registration



Product registration is entirely voluntary and failure to complete or return this form will not diminish your warranty rights.